



GigE Line Scan Camera

User Manual

Legal Information

© 2021 Hangzhou Hikrobot Technology Co., Ltd. All rights reserved.

About This Manual

The Manual includes instructions for using and managing the Product. Pictures, charts, images and all other information hereinafter are for description and explanation only. The information contained in the Manual is subject to change, without notice, due to firmware updates or other reasons. Please find the latest version of this Manual at the Hikrobot website (<https://en.hikrobotics.com/>). Please use this Manual with the guidance and assistance of professionals trained in supporting the Product.

Trademarks

HIKROBOT and other Hikrobot's trademarks and logos are the properties of Hikrobot in various jurisdictions. Other trademarks and logos mentioned are the properties of their respective owners.

Disclaimer

TO THE MAXIMUM EXTENT PERMITTED BY APPLICABLE LAW, THIS MANUAL AND THE PRODUCT DESCRIBED, WITH ITS HARDWARE, SOFTWARE AND FIRMWARE, ARE PROVIDED "AS IS" AND "WITH ALL FAULTS AND ERRORS". HIKROBOT MAKES NO WARRANTIES, EXPRESS OR IMPLIED, INCLUDING WITHOUT LIMITATION, MERCHANTABILITY, SATISFACTORY QUALITY, OR FITNESS FOR A PARTICULAR PURPOSE. THE USE OF THE PRODUCT BY YOU IS AT YOUR OWN RISK. IN NO EVENT WILL HIKROBOT BE LIABLE TO YOU FOR ANY SPECIAL, CONSEQUENTIAL, INCIDENTAL, OR INDIRECT DAMAGES, INCLUDING, AMONG OTHERS, DAMAGES FOR LOSS OF BUSINESS PROFITS, BUSINESS INTERRUPTION, OR LOSS OF DATA, CORRUPTION OF SYSTEMS, OR LOSS OF DOCUMENTATION, WHETHER BASED ON BREACH OF CONTRACT, TORT (INCLUDING NEGLIGENCE), PRODUCT LIABILITY, OR OTHERWISE, IN CONNECTION WITH THE USE OF THE PRODUCT, EVEN IF HIKROBOT HAS BEEN ADVISED OF THE POSSIBILITY OF SUCH DAMAGES OR LOSS.

YOU ACKNOWLEDGE THAT THE NATURE OF INTERNET PROVIDES FOR INHERENT SECURITY RISKS, AND HIKROBOT SHALL NOT TAKE ANY RESPONSIBILITIES FOR ABNORMAL OPERATION, PRIVACY LEAKAGE OR OTHER DAMAGES RESULTING FROM CYBER-ATTACK, HACKER ATTACK, VIRUS INFECTION, OR OTHER INTERNET SECURITY RISKS; HOWEVER, HIKROBOT WILL PROVIDE TIMELY TECHNICAL SUPPORT IF REQUIRED.

YOU AGREE TO USE THIS PRODUCT IN COMPLIANCE WITH ALL APPLICABLE LAWS, AND YOU ARE SOLELY RESPONSIBLE FOR ENSURING THAT YOUR USE CONFORMS TO THE APPLICABLE LAW. ESPECIALLY, YOU ARE RESPONSIBLE, FOR USING THIS PRODUCT IN A MANNER THAT DOES NOT INFRINGE ON THE RIGHTS OF THIRD PARTIES, INCLUDING WITHOUT LIMITATION, RIGHTS OF PUBLICITY, INTELLECTUAL PROPERTY RIGHTS, OR DATA PROTECTION AND OTHER PRIVACY RIGHTS. YOU SHALL NOT USE THIS PRODUCT FOR ANY PROHIBITED END-USES, INCLUDING THE DEVELOPMENT OR PRODUCTION OF WEAPONS OF MASS DESTRUCTION, THE DEVELOPMENT OR PRODUCTION OF CHEMICAL OR BIOLOGICAL WEAPONS, ANY ACTIVITIES IN THE CONTEXT RELATED

TO ANY NUCLEAR EXPLOSIVE OR UNSAFE NUCLEAR FUEL-CYCLE, OR IN SUPPORT OF HUMAN RIGHTS ABUSES.

THE PERFORMANCE DATA IN THIS PUBLICATION IS BASED ON HIKROBOT'S INTERNAL RESEARCH/EVALUATION. ACTUAL DATA MAY VARY DEPENDING ON SPECIFIC CONFIGURATIONS AND OPERATING CONDITIONS AND HIKROBOT SHALL NOT BEAR THE CONSEQUENCES ARISING THEREFROM. IN THE EVENT OF ANY CONFLICTS BETWEEN THIS MANUAL AND THE APPLICABLE LAW, THE LATER PREVAILS.

Regulatory Information

FCC Information

Please take attention that changes or modification not expressly approved by the party responsible for compliance could void the user's authority to operate the equipment.

FCC compliance: This equipment has been tested and found to comply with the limits for a Class A digital device, pursuant to part 15 of the FCC Rules. These limits are designed to provide reasonable protection against harmful interference when the equipment is operated in a commercial environment. This equipment generates, uses, and can radiate radio frequency energy and, if not installed and used in accordance with the instruction manual, may cause harmful interference to radio communications. Operation of this equipment in a residential area is likely to cause harmful interference in which case the user will be required to correct the interference at his own expense.

FCC Conditions

This device complies with part 15 of the FCC Rules. Operation is subject to the following two conditions:

1. This device may not cause harmful interference.
2. This device must accept any interference received, including interference that may cause undesired operation.

EU Conformity Statement

 This product and - if applicable - the supplied accessories too are marked with "CE" and comply therefore with the applicable harmonized European standards listed under the EMC Directive 2014/30/EU, the LVD Directive 2014/35/EU, the RoHS Directive 2011/65/EU.



2012/19/EU (WEEE directive): Products marked with this symbol cannot be disposed of as unsorted municipal waste in the European Union. For proper recycling, return this product to your local supplier upon the purchase of equivalent new equipment, or

dispose of it at designated collection points. For more information see: www.recyclethis.info



2006/66/EC (battery directive): This product contains a battery that cannot be disposed of as unsorted municipal waste in the European Union. See the product documentation for specific battery information. The battery is marked with this symbol, which may include lettering to indicate cadmium (Cd), lead (Pb), or mercury (Hg). For proper recycling, return the battery to your supplier or to a designated collection point. For more information see: www.recyclethis.info

Korea Certification

이 기기는 업무용 환경에서 사용할 목적으로 적합성평가를 받은 기기로서 가정용 환경에서 사용하는 경우 전파간섭의 우려가 있습니다.

Symbol Convention

The symbols that may be found in this document are defined as follows.

Symbol	Description
NOTE	Provides additional information to emphasize or supplement important points of the main text.
WARNING	Indicates a potentially hazardous situation, which if not avoided, could result in equipment damage, data loss, performance degradation, or unexpected results.
DANGER	Indicates a hazard with a high level of risk, which if not avoided, will result in death or serious injury.

Available Model

This manual is applicable to the GigE Line Scan Camera.

Safety Instructions

These instructions are intended to ensure that the user can use the device correctly to avoid danger or property loss.

Laws and Regulations

The device should be used in compliance with local laws, electrical safety regulations, and fire prevention regulations.

Power Supply

- When wiring or dismantling, make sure that the device power is cut off, and do not operate

under electrification.

- Avoid contact with exposed circuit. When the device is powered on, avoid contact with exposed junctions and parts.
- Use the power adapter provided by the regular manufacturer.
- Do not connect multiple devices to one power adapter, to avoid over-heating or fire hazards caused by overload.
- Make sure the plug is properly connected to the power socket.

Transportation

- The device contains precision optical components and electronic components. During transportation, storage and installation, incorrect operations like heavy pressure and violent vibration should be avoided. Otherwise, the device may be damaged.
- Avoid sudden collision, and pack the device with the accompanied carton and cushioning material or similar package.

Using Environment

- In order to reduce the risk of fire or electric shock, do not let the device get wet or damp.
- Do not drop objects onto the device and avoid vigorous vibration.
- Keep the device away from magnetic interference.
- Do not use the device in extremely heat, extremely cold, dusty environment, corrosive environment or high humidity environment.
- Do not aim the device lens at objects of strong light, such as the sun and incandescent lamp. Otherwise, the lens may be damaged.
- The device should be stored in dry environment without corrosive gas. Avoid placing the device in direct sunlight and poorly ventilated locations, or near heat sources such as heater or heating (ignoring this warning may lead to fire hazards).
- Do not operate in explosive environment.
- Keep the surrounding area well ventilated to avoid heat accumulation. Do not contact the radiator directly to avoid scald.

Electrostatic Protection

- Remove all conductive objects (such as jewelry, watch, etc.) on the device body before touching the device, and touch the grounding metal bracket by hand to release the static electricity.
- It is suggested to wear anti-static suit to prevent damage to the equipment caused by static electricity.
- When installing or maintaining the device, wear anti-static wristband or anti-static gloves. Make sure that the wristband is tightly attached to the skin and is reliably grounded.
- It is forbidden to touch exposed circuit boards with bare hands. Static electricity generated by human body may damage electrostatic sensitive components on circuit boards.
- When touching electrostatic sensitive components or devices, proper grounding measures must be taken.
- Put electrostatic sensitive components into anti-static bags for protection.
- It is suggested to place humidifier in dry environment to maintain suitable humidity and reduce static electricity generation.

Maintenance

- If the device is not working properly, contact the store or the nearest service center. Do not disassemble or modify the device in any way. (The company does not bear any liability for any problem arising from unauthorized modification or maintenance).
- Properly preserve all the original packaging materials of the device so that when problems arise, the device can be packed with packaging materials and sent to the agent or returned to the manufacturer for processing. The company does not bear any liability for accidental damage during transportation caused by non-original packaging.
- This device is a precision electronic device, no components can be maintained by user, do not disassemble the device arbitrarily.

Cleaning

Do not touch the image sensor directly. If the sensor needs to be cleaned, use a clean rag and wet it with alcohol, then gently wipe off the dirt; if the device is not in use, cover the image sensor with dust cover for protection.

Installation

Do not install the device on vibrating surface or places that are vulnerable to impact.

Personnel Requirement

Quality requirements for installation and maintenance personnel: qualification certificate or working experience in weak current system installation and maintenance, and relevant working experience and qualifications. Besides, the personnel must possess the following knowledge and operation skills:

- The basic knowledge and operation skills of low voltage wiring and low voltage electronic circuit connection.
- The ability to comprehend the contents of this manual.

Contact Information

Hangzhou Hikrobot Technology Co., Ltd.

No. 399 Danfeng Road, Binjiang District, Hangzhou, 310051, China

E-mail: tech_support@hikrobotics.com

Website: <https://en.hikrobotics.com/>

Table of Contents

Chapter 1 Overview	1
1.1 Introduction	1
1.2 Key Feature.....	1
Chapter 2 Appearance	2
Chapter 3 Interface and Indicator	4
3.1 Power and I/O Interface	4
3.1.1 First Type of Pin Definitions	4
3.1.2 Second Type of Pin Definitions.....	5
3.2 Indicator	6
Chapter 4 Camera Installation	7
4.1 Installation Preparation.....	7
4.2 Install Camera.....	7
Chapter 5 Camera Connection	8
5.1 Install Client Software	8
5.2 Turn off Firewall	9
5.3 Set PC Network	10
5.4 Set Camera Network	11
5.5 Connect Camera to Client Software.....	12
Chapter 6 Client Software Layout	13
Chapter 7 Image Acquisition	16
7.1 Set Line Rate.....	16
7.2 Set Frame Timeout.....	17
7.3 Set Acquisition Mode	18
7.4 Set Trigger Mode	19
7.5 Set Trigger Source	20
7.5.1 Set Software Trigger	21
7.5.2 Set Hardware Trigger.....	22
7.5.3 Set Shaft Encoder Control	23
7.5.4 Set Frequency Converter Control.....	26
7.5.5 View Trigger Line Rate	27
7.5.6 Set Action Command Trigger	28
7.5.7 Set Free Trigger	30
7.6 Trigger Related Parameters	30

7.6.1 Acquisition Burst Frame Count	31
7.6.2 Trigger Activation	32
7.6.3 Trigger Delay.....	34
7.6.4 Frame/Line Trigger Cache	35
7.6.5 Trigger Debouncer.....	37
Chapter 8 I/O Output	39
8.1 Select Output Signal	39
8.2 Set Output Signal.....	39
8.2.1 Enable Line Inverter	40
8.2.2 Enable Strobe Signal.....	40
Chapter 9 I/O Electrical Feature and Wiring	45
9.1 I/O Introduction	45
9.2 I/O Electrical Feature.....	45
9.2.1 Differential Input Circuit.....	45
9.2.2 Differential Output Circuit.....	46
9.2.3 Bi-Direction I/O Circuit	47
9.3 Input Wiring	49
9.3.1 First Type of Input Wiring	49
9.3.2 Seond Type of Input Wiring	52
9.4 Output Wiring	54
Chapter 10 Image Parameter	56
10.1 Image Resolution.....	56
10.2 Set ROI.....	56
10.3 Set Image Reverse	57
10.4 Set Image Compression Mode	58
10.5 Set Pixel Format	58
10.6 Set Test Pattern	60
10.7 Set Binning	62
10.8 Set Exposure Auto	63
10.9 Set HDR	64
10.10 Set Gain	64
10.10.1 Set Analog Gain	65
10.10.2 Set Digital Gain.....	66
10.11 Set Brightness.....	67
10.12 Set Black Level.....	67

10.13 Set White Balance	68
10.14 Set Gamma Correction	69
10.15 Set AOI	71
10.16 Set Color Transformation Control	72
10.17 Set Hue	73
10.18 Set Saturation	74
10.19 Set Color Adjustment	75
10.20 Set LUT	76
10.21 Set Flat Field Correction	77
10.21.1 FPNC Correction	77
10.21.2 PRNUC Correction	77
10.22 Set Space Correction	80
10.22.1 Set Line Rate Ratio	81
10.22.2 Set Pixel Shift and Parallax Direction	82
Chapter 11 Other Functions	84
11.1 Device Control	84
11.2 Embedded Information in Image	86
11.3 TDI Function	89
11.4 Scan Direction	90
11.5 File Access Control	91
11.6 Event Control	93
11.7 Transport Layer Control	94
11.8 Transfer Control	98
11.9 Save and Load User Set	98
11.10 Set Multicast	100
11.11 Update Firmware	102
Chapter 12 Troubleshooting	104
Chapter 13 Revision History	105
Appendix A Camera Parameter Index	107

Chapter 1 Overview

1.1 Introduction

The GigE line scan camera uses the GigE interface to transmit images in real time, and it acquires images and sets parameters via the client software or SDK. The camera is applicable to the printing, textiles, railway, logistics, metallurgy, food, pharmaceutical manufacturing, material sorting, etc.

1.2 Key Feature

- Supports auto and manual adjustment for gain, exposure time and white balance, manual adjustment for Look-Up Table (LUT), Gamma correction, etc.
- Adopts the image interpolation algorithm for the color reproduction.
- Adopts GigE interface and max. transmission distance of 100 meters without relay.
- Compatible with the GigE Vision Protocol, the GenICam Standard, and the third-party software based on the protocol and standard.



NOTE

- The camera functions may differ by camera models.
- For specific camera functions, refer to the camera's user manual.

Chapter 2 Appearance

 **NOTE**

Appearances here are for reference only. Refer to the camera's specification for detailed dimension information and corresponding models.

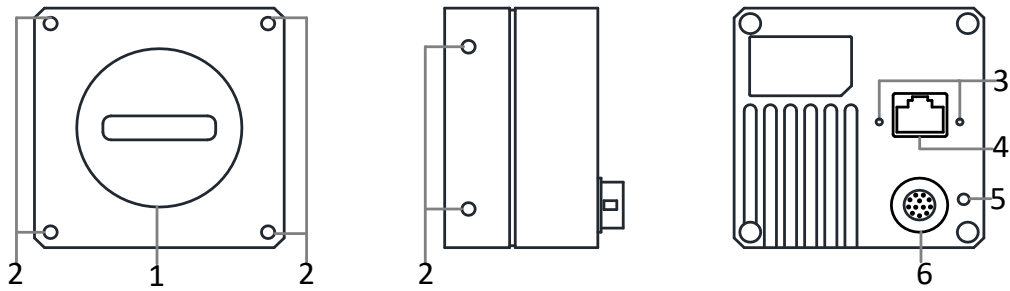

Figure 2-1 Appearance (Type I)

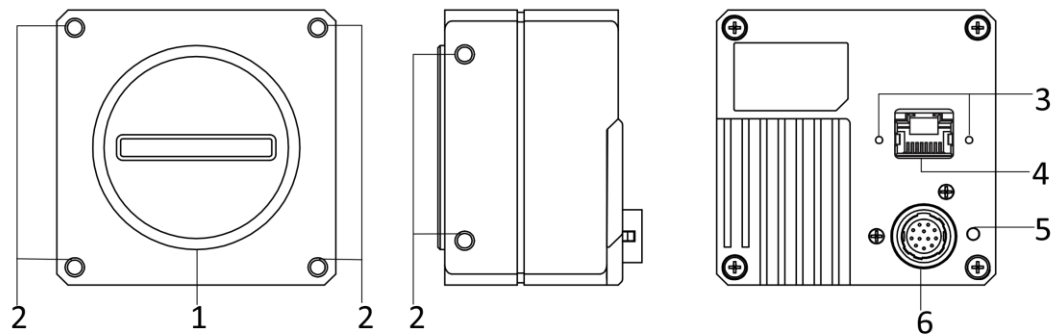

Figure 2-2 Appearance (Type II)

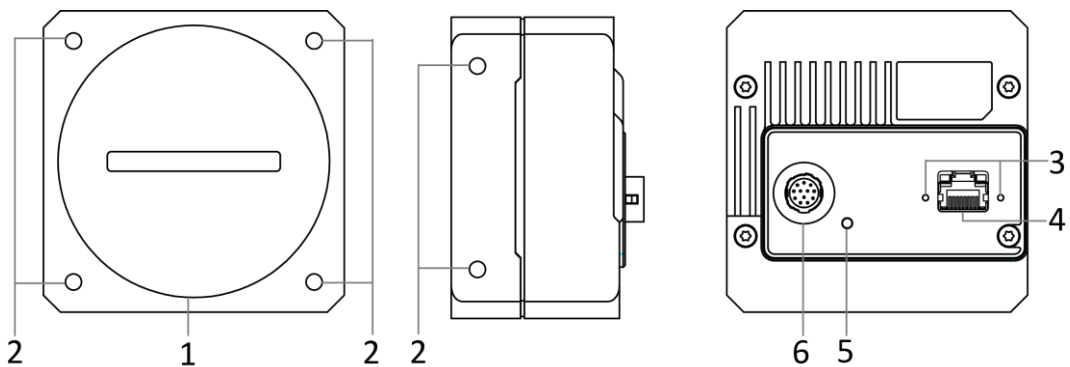

Figure 2-3 Appearance (Type III)

Table 2-1 Component Description

No.	Name	Description
1	Lens Mount	It is used to install the lens.
2	Screw Hole	It is used to fix the camera to the installation position.
3	Screw Hole for GigE Interface	It refers to the M2 screw hole for securing the network cable.
4	Gigabit Ethernet Interface	It refers to the Gigabit Ethernet interface for transmitting data.
5	LED Indicator	It indicates the camera's status.
6	Power and I/O Interface	It provides power supply, input/output signal, serial port, etc.

Refer to the table below for the relation between camera model and camera appearance type.

Table 2-2 Camera Model and Appearance Type

Camera Model	Camera Appearance Type
MV-CL021-40GM MV-CL022-40GC MV-CL042-90GM/GC	Type I camera
MV-CL022-91GM/GC MV-CL042-91GM/GC	Type II camera
MV-CL084-91GM MV-CL086-91GC	Type III camera

Chapter 3 Interface and Indicator

3.1 Power and I/O Interface

All GigE line scan cameras have the same 12-pin power and I/O interface, as shown below.

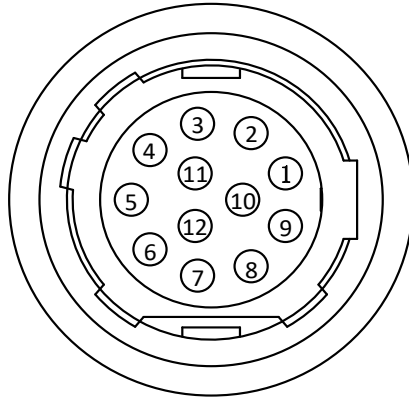

Figure 3-1 12-Pin Interface

But the specific pin definitions differ by camera models. Currently, two pin definitions are available:

- The first type of pin definitions is applicable to MV-CL021-40GM, MV-CL022-40GC, and MV-CL042-90GM/GC.
- The second type of pin definitions is applicable to other camera models.

3.1.1 First Type of Pin Definitions

 **NOTE**

Refer to the pin definitions and labels attached to the power and I/O cable to wire the device.

Table 3-1 Pin Definitions (First Type)

No.	Signal	I/O Signal Source	Description
1	GND	--	Power supply ground
2	DC_PWR	--	DC Power supply positive
3	IO_IN0_P	Line 0+	Differential input IO 0+
4	IO_IN0_N	Line 0-	Differential input IO 0-

No.	Signal	I/O Signal Source	Description
5	GND	Line 2-	Power supply ground
6	IO_IN1_P	Line 3+	Differential input IO 1+
7	IO_IN1_N	Line 3-	Differential input IO 1-
8	IO2	Line 2+	Bi-directional IO
9	IO_OUT0_P	Line 1+	Differential output IO 0+
10	IO_OUT0_N	Line 1-	Differential output IO 0-
11	IO_OUT1_P	Line 4+	Differential output IO 1+
12	IO_OUT1_N	Line 4-	Differential output IO 1-

3.1.2 Second Type of Pin Definitions



NOTE

Refer to the pin definitions and labels attached to the power and I/O cable to wire the device.

Table 3-2 Pin Definitions (Second Type)

No.	Signal	I/O Signal Source	Description
1	GND	--	Power supply ground
2	DC_PWR	--	DC power supply positive
3	LINE0_P	Line 0+	Differential input/output IO 0+
4	LINE0_N	Line 0-	Differential input/output IO 0-
5	GND	--	Power supply ground
6	LINE3_P	Line 3+	Differential input/output IO 3+
7	LINE3_N	Line 3-	Differential input/output IO 3-
8	LINE4_P	Line 4+	Differential input/output IO 4+

No.	Signal	I/O Signal Source	Description
9	LINE1_P	Line 1+	Differential input/output IO 1+
10	LINE1_N	Line 1-	Differential input/output IO 1-
11	DC_PWR	--	DC power supply positive
12	LINE4_N	Line 4-	Differential input/output IO 4-

3.2 Indicator

The camera indicator is used to display camera status.

Table 3-3 Indicator Description

No.	Indicator Color	Status	Description
1	Red	Flashing very slowly	Cable connection error occurs.
2	Red	Solid	Major error occurs.
3	Blue	Flashing slowly	The camera is acquiring images under trigger mode.
4	Blue	Flashing rapidly	The camera is acquiring images normally.
5	Blue	Solid	The camera is in idle status.
6	Red and blue	Flash alternatively	The function of finding me is executed, or the firmware is updating.

NOTE

- When the indicator is flashing rapidly, flashing slowly, or flashing very slowly, its unlit interval is 0.2 s, 1 s, 2 s respectively.
- The indicator sometimes may show a purple color when red and blue colors flashing at the same time.

Chapter 4 Camera Installation

4.1 Installation Preparation

You need to prepare following accessories before installation.

Table 4-1 Accessories

No.	Name	Quantity	Description
1	Lens	1	You should purchase lens separately according to the camera's lens mount.
2	Lens Adapter	1	You should purchase lens adapter separately according to the camera's lens mount and lens you use.
3	Power and I/O Cable	1	It refers to the 12-pin power and I/O cable that you need to purchase separately.
4	Power Adapter or Switch Power Supply	1	You should select suitable power adapter or switch power supply according to the camera power supply and consumption. You need to purchase it separately.
5	Network Cable	1	The CAT-5e network cable or above. You need to purchase it separately.

4.2 Install Camera

Before you start

Make sure all the related devices are powered off during the installation.

Steps:

1. Fix the camera to the installation position, and install lens and lens adapter to the camera.
2. Use a suitable network cable to connect the camera with a switch or a network interface card.
3. Select a power supply method.
 - Direct supply: Use the 12-pin power and I/O cable to connect the camera to a power adapter.
 - PoE (Power over Ethernet): For the camera that supports PoE, use a suitable network cable to connect the camera to a switch that supports PoE or a network interface card.

Chapter 5 Camera Connection

Camera connection to the client software is required for the camera's configuration and remote operations. This section introduces how to install the client software, set PC and camera network, connect the camera to the client software, etc.

5.1 Install Client Software

MVS client software is used to connect the camera, set its parameters, etc.

NOTE

- The MVS client software is compatible with 32/64-bit Windows XP/7/10, 32/64-bit Linux, and 64-bit MacOS operating systems. Here we take Windows as an example.
- The graphic user interface may differ by different versions of the client software you use.
- You can download the MVS client software from <https://en.hikrobotics.com/>.

Steps:

1. Double click the MVS installation package.
2. Select the language.
3. Read and check **Terms of the License Agreement**.

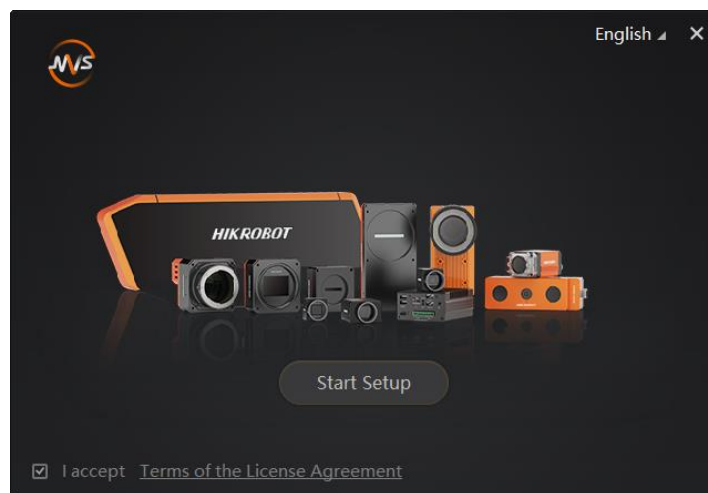

Figure 5-1 Installation Interface

4. Click **Start Setup**.

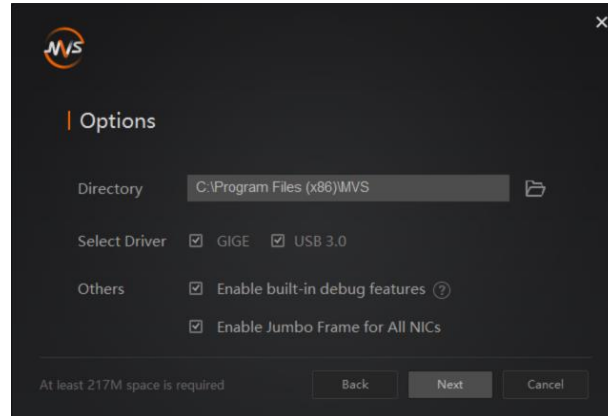

Figure 5-2 Default Settings

5. Keep default settings, and click **Next**.
6. Finish the installation according to the interface prompts.

5.2 Turn off Firewall

To ensure stable client running and image transmission, you are recommended turning off Windows firewall before using the client software.

NOTE

For different Windows versions, the path name or interface may differ.

Steps:

1. Go to Windows Firewall.
 - Windows XP system: Click **Start > Control Panel > Security Center > Windows Firewall**.
 - Windows 7 system: Click **Start > Control Panel > Windows Firewall**.
 - Windows 10 system: Click **Start > Control Panel > System and Security > Windows Defender Firewall**.
2. Click **Turn Windows Defender Firewall on or off** on the left.
3. Select **Turn off Windows Defender Firewall (not recommended)**.

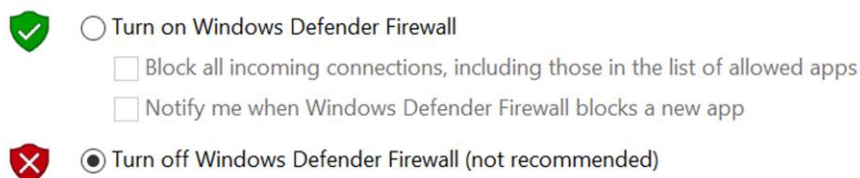

Figure 5-3 Windows Defender Firewall

4. Click **OK**.

5.3 Set PC Network

To ensure stable image transmission and normal communication between the PC and the camera via client software, you need to set the PC network before using the client software.

NOTE

For different Windows versions, the path name or interface may differ.

Steps:

1. Go to PC network settings page: **Start > Control Panel > Network and Internet > Network and Sharing Center > Change adapter settings.**
2. Select NIC and set the IP obtainment mode.
 - Select **Obtain an IP address automatically** to get an IP address of the PC automatically.
 - Select **Use the following IP address** to set an IP address for the PC manually.
3. Set NIC property via the PC.
 - 1) Go to NIC settings page: **Control Panel > Hardware and Sound > Device Manager > Network Adapter.**
 - 2) Select corresponding network interface card, and click **Advanced.**
 - 3) Set **Jumbo Packet** value to 9014 Bytes, **Transmit Buffers** and **Receive Buffers** to 2048, **Interrupt Moderation Rate** to Extremum.
4. (Optional) Set NIC property via the MVS.
 - 1) Right click the Ethernet, and click **NIC Settings.**

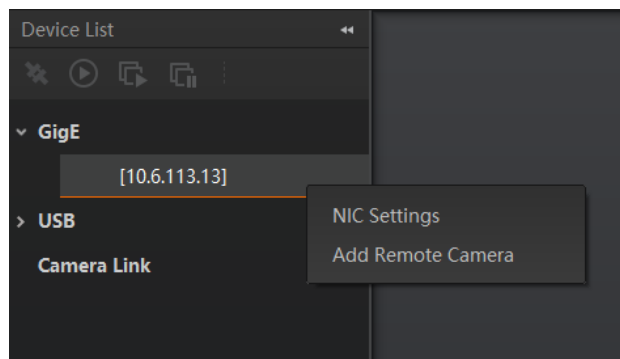

Figure 5-4 NIC Settings

- 2) Enable **Jumbo Frame**, and set **Receive Buffers** and **Transmit Buffers** to 2048.

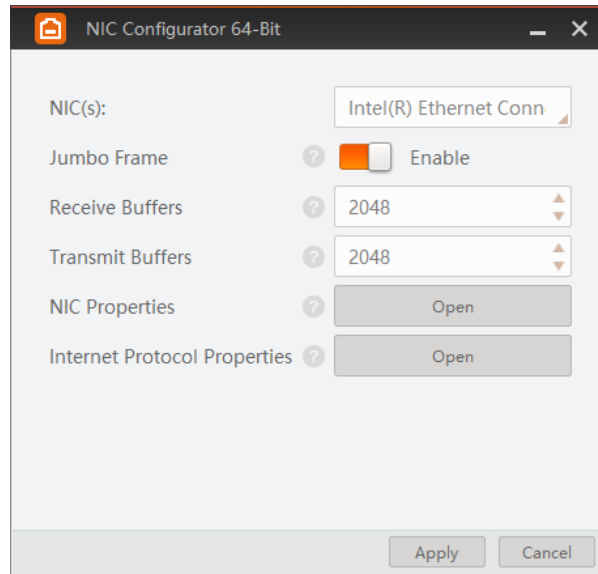

Figure 5-5 NIC Configurator

NOTE

The max. value of receive buffers and transmit buffers may differ by network interface cards.

5.4 Set Camera Network

You can set and operate the camera in the client software only when the camera is in the same network segment with the PC where the client software is installed.

Steps:

1. Double click the client software to run it.
2. Click  in device list to search the device.
3. Select a device to be connected.
4. Right click the device, and click **Modify IP**.
5. Set the IP address of the device in the same network segment with the PC
6. Click **OK**.

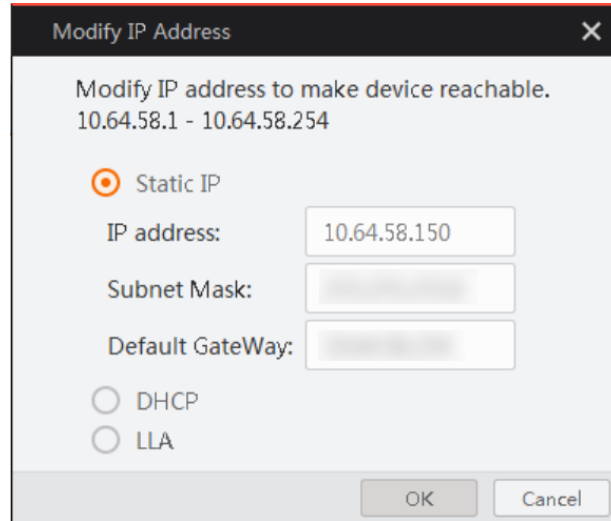



Figure 5-6 Modify Device IP Address

5.5 Connect Camera to Client Software

Make sure your device IP address is in the same network segment with the PC where you installed the client software before connecting the device to it.

Double click the device name in device list, or click  to connect the device to the client.

Chapter 6 Client Software Layout

After connecting to the camera, the client software can read the camera attributes and display them.

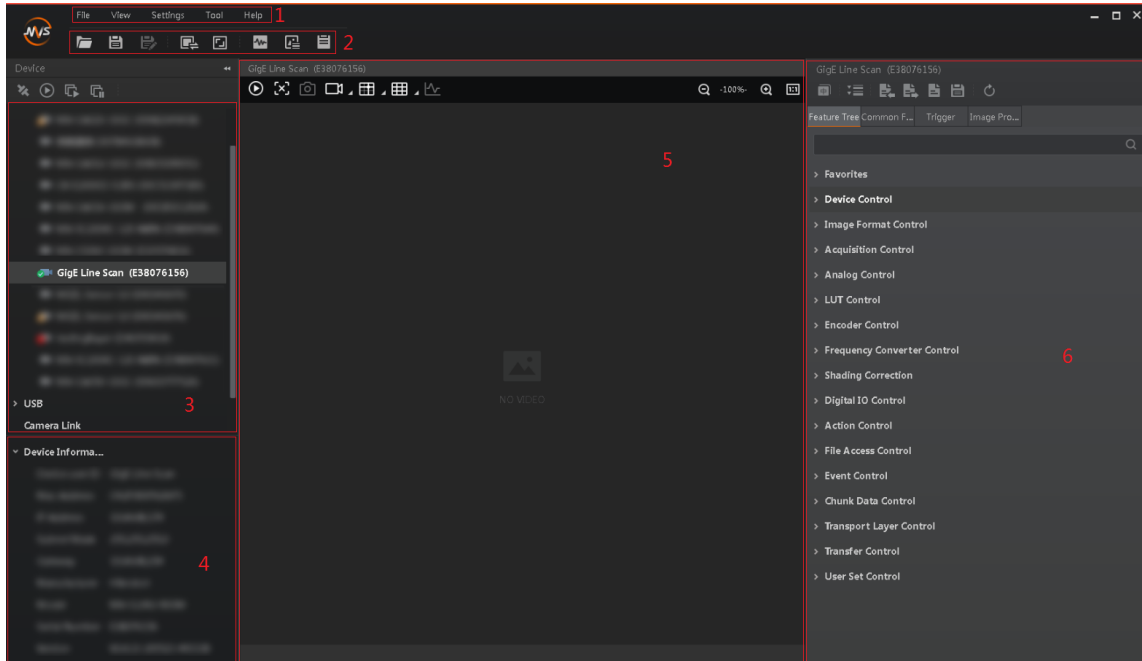

Figure 6-1 Main Window

NOTE

For specific main window of the client software, please refer to the actual one you got.

Table 6-1 Description of Main Window

No.	Area Name	Description
1	Menu Bar	The menu bar displays function modules, including File, View, Settings, Tool, and Help.
2	Control Toolbar	The control toolbar provides quick operations for the device.
3	Device List Panel	This panel displays device list, and you can connect or disconnect device, modify device IP address, etc.
4	Device Information Panel	This panel displays the detailed device information.

No.	Area Name	Description
5	Display Window	This area displays the acquisition images in real-time. You can click different icons to capture and save image, record, etc.
6	Feature Panel	You can view and set features of the selected camera, and perform operations such as importing, exporting, and saving features.

Click  in the camera's feature panel to unfold the specific camera parameters, and set them according to actual demands.

 **NOTE**

The camera's attribute tree and parameters may differ by camera models.

Table 6-2 Attribute Description

Attribute	Description
Device Control	You can view device information, edit its name, reset the device, etc.
Image Format Control	You can view and set the device resolution, image reverse function, pixel format, region of interest, test pattern, etc.
Acquisition Control	You can view and set the device acquisition mode, line rate, trigger mode, exposure mode, etc.
Analog Control	You can view and set the device gain, black level, Gamma correction, etc.
Color Transformation Control	You can view and set the device color transformation related parameters like hue and saturation.
LUT Control	You can view the Look-Up Table (LUT) and set its index and value.
Encoder Control	You can set encoder control to convert source signal of external trigger into internal signal.
Frequency Converter Control	You can set frequency converter control to convert external signal of different frequencies into internal signal.
Shading Correction	You can set shading correction to correct shade.
Digital IO Control	You can set the different input and output signals.

Attribute	Description
Action Control	You can view and set the device's action control related parameters.
Counter And Timer Control	You can view and set the counter related parameters.
File Access Control	You can view and set the device file access control related parameters.
Event Control	You can view and set the device's event control related parameters to let the device generate an event and transmit a related event message to the computer.
Chunk Data Control	You can view and set the device's chunk data control related parameters to generate supplementary image data and append that data to every image that you acquire.
Transport Layer Control	You can view and set the parameters of the device's transport layer.
Transfer Control	You can view the device' transfer status.
User Set Control	You can save or load the device's parameters.

Chapter 7 Image Acquisition

7.1 Set Line Rate

Line rate refers to the image line number that is output by the camera per second. The frame rate of the camera is proportional to the line rate, and is inversely proportional to the height of the image area, that is, $Fps=Lps \text{ (line rate)}/\text{Height (image height)}$.

The following 4 factors determine the maximum line rate:

- Readout time: The less the readout time and the higher the line rate will be.
- Exposure time: The less the exposure time, the higher the line rate will be.
- Pixel format: The more bytes pixel format occupy, the lower the line rate will be.
- Bandwidth: The larger the bandwidth, the higher the line rate will be.
- Image compression mode: This function is used to compress data before transmitting to the PC, and increase the frame rate to some extent.

In client software, click **Acquisition Control > Acquisition Line Rate (Hz)**, and enter **Acquisition Line Rate (Hz)**. You can view real-time line rate and frame rate in **Resulting Line Rate (Hz)** and **Resulting Frame Rate (Hz)** respectively.

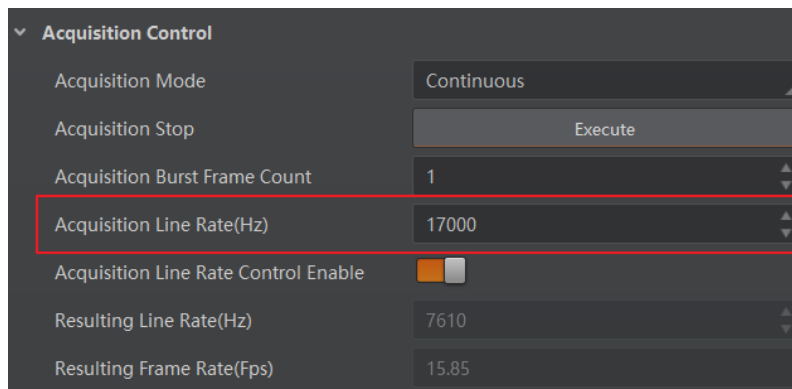

Figure 7-1 Set Line Rate

When you enable the image compression mode (see section **Set Image Compression Mode** for details), you can view **Reference Line Rate (Hz)** that stands for the min. line rate that is calculated according to compression ratio.

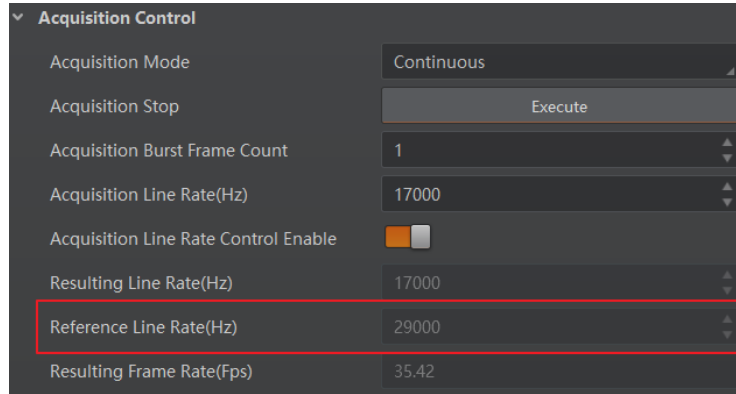

Figure 7-2 View Reference Line Rate

NOTE

- For different models of camera, the image compression mode function may differ, and the actual product you purchased shall prevail.
- After enabling the image compression mode, the camera's line rate and frame rate are related with exposure and camera sensor only.

7.2 Set Frame Timeout

NOTE

The frame timeout function may differ be camera models.

- If the frame timeout function is disabled, the camera outputs one frame image after its outputted line quantity reaches the configured height value, and the camera will wait line quantity data if the outputted line quantity does not reach the configured height value.
- If the frame timeout function is enabled, the camera outputs one frame image after its outputted line quantity reaches the configured height value in the configured frame timeout time.

You can set **Partial Frame Discard** and **Abandon Extra Image** in **Acquisition Control** if the camera's outputted line quantity does not reach the configured height value in the configured frame timeout time.

Table 7-1 Parameters Description

Partial Frame Discard	Abandon Extra Image	Description
Disabled	Disabled	The camera outputs one frame image after it finishes image complement.
Disabled	Enabled	The camera discards partial images and outputs remaining images.

Partial Frame Discard	Abandon Extra Image	Description
Enabled	Disabled	The camera discards the entire image data.
Enabled	Enabled	The camera discards the entire image data.

Follow steps below to enable the frame timeout function.

Steps:

1. Click **Acquisition Control**, and enable **Frame Timeout Enable**.
2. Set **Frame Timeout Time** according to actual demands.
3. Enable or disable **Partial Frame Discard** and **Abandon Extra Image** according to actual demands.

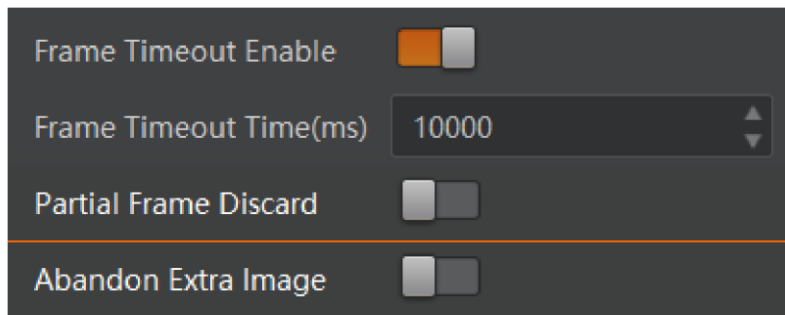

Figure 7-3 Set Frame Timeout

7.3 Set Acquisition Mode

The camera has 2 acquisition modes, including **SingleFrame** mode and **Continuous** mode.

- **SingleFrame** mode: When camera starting image acquisition, it acquires one image only, and then stops.
- **Continuous** mode: When camera starting image acquisition, it acquires images continuously. Real-time frame rate decides the acquisition frame number per second. You can stop camera image acquisition manually.

Click **Acquisition Control > Acquisition Mode**, and select **Continuous** or **SingleFrame** as **Acquisition Mode** according to actual demands.

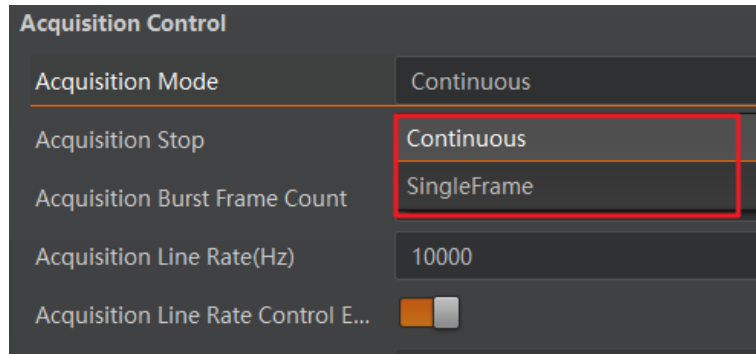

Figure 7-4 Set Acquisition Mode

7.4 Set Trigger Mode

The camera has 4 types of trigger modes, including internal trigger mode, line trigger mode, frame trigger mode, and line + frame trigger mode.

Table 7-2 Trigger Mode Principle and Parameter

Trigger Mode	Parameter	Parameter Value	Principle
Internal trigger mode	Acquisition Control > Trigger Selector and Trigger Mode	Trigger Selector =Line Start Trigger Mode = Off and Trigger Selector =Frame Burst Start Trigger Mode =Off	The camera itself generates the triggering signals of this mode, and you can adjust the line rate parameters according to actual demand.
Line trigger mode	Acquisition Control > Trigger Selector and Trigger Mode	Trigger Selector =Line Start Trigger Mode = On and Trigger Selector =Frame Burst Start Trigger Mode = Off	Under this mode, the frequency of the external line trigger control signal determines the line rate, and only one line is exposed when a trigger signal is input.
Frame trigger mode	Acquisition Control > Trigger Selector and Trigger Mode	Trigger Selector =Frame Burst Start Trigger Mode = On and	After receiving frame trigger signal, camera will start to expose and generate image data. The camera outputs images according to current settings. You do not need to set line trigger signal. For max. line rate that camera supports, please refer to the

Trigger Mode	Parameter	Parameter Value	Principle
		Trigger Selector =Line Start Trigger Mode = Off	camera specification.
Line + frame trigger mode	Acquisition Control > Trigger Selector and Trigger Mode	Trigger Selector =Line Start Trigger Mode =On and Trigger Selector =Frame Burst Start Trigger Mode =On	In this mode, the camera's external frame trigger signal and line trigger signal is required. The line number of a frame is controlled by the frame height register, and the line rate is controlled by an externally supplied line trigger signal, while being limited by the internal configured value. Only after the frame trigger signal arrives, the line trigger signal will work.

7.5 Set Trigger Source

Apart from the internal trigger mode, you need to set the trigger source for line trigger or frame trigger if their trigger signals come from external signals. Six types of trigger sources are available, including software trigger, hardware trigger, shaft encoder control, frequency converter control, action command trigger, and free trigger.

NOTE

The software trigger and action command trigger are valid for the frame trigger only, and the shaft encoder control is valid for the line trigger only.

Table 7-3 External Trigger Mode Principle and Parameter

Trigger Source	Parameter	Parameter Value	Principle
Software trigger	Acquisition Control > Trigger Source	Software	The software sends trigger signal to the camera via Gigabit Ethernet to acquire images.
Hardware trigger	Acquisition Control > Trigger Source	Specific Line	External device connects camera via camera I/O interface. External device sends trigger signal to camera to acquire images.

Trigger Source	Parameter	Parameter Value	Principle
Shaft encoder control	Acquisition Control > Trigger Source	Encoder Module Out	This trigger source uses shaft encoder module to receive signal A and signal B with phase difference. After internal computing of the module, the outputted signal can be used as camera's trigger signal.
Frequency converter control	Acquisition Control > Trigger Source	Frequency Converter	This trigger source allows different frequency between trigger camera signal and required input signal.
Action command trigger	Acquisition Control > Trigger Source	Action 1	The action command sends trigger signal to the camera to acquire images. You can select this trigger source only when the frame trigger mode is set.
Free trigger	Acquisition Control > Trigger Source	Anyway	Use trigger sources mentioned above to send trigger signal to the camera to acquire images.

**NOTE**

- The trigger source may differ by camera models.
- These trigger sources are valid only the frame trigger mode, line trigger mode or line + frame trigger mode is enabled.
- In line + frame trigger mode, if the trigger source selected and trigger parameters configured for the frame trigger and the line trigger are the same, and then the first signal of the trigger source is used as the frame trigger signal to let the camera acquire images. The subsequent signals used as the line trigger signal to acquire images until the completion of one frame image.

7.5.1 Set Software Trigger

The camera supports software trigger. When the software trigger is selected, the client software sends commands via Gigabit Ethernet to camera to acquire and transmit images.

Steps:

1. Click **Acquisition Control > Trigger Selector**.
2. Select **Frame Burst Start** as **Trigger Selector**, and **On** as **Trigger Mode**.

3. Select **Software** as **Trigger Source**, and click **Execute** in **Trigger Software** to send trigger commands.

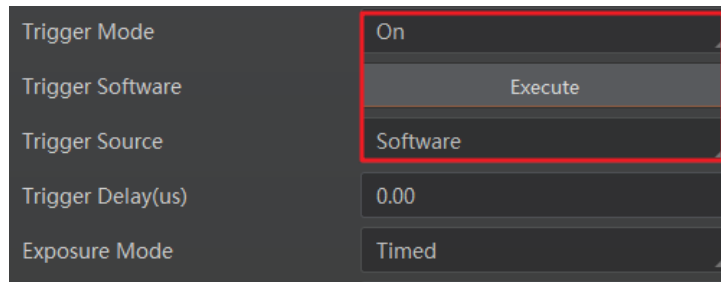

Figure 7-5 Set Software Trigger

7.5.2 Set Hardware Trigger

If the camera enables the frame trigger or line trigger, you can select specific lines as trigger source to enable hardware trigger. At this time, external devices send commands to the camera to acquire images.

**NOTE**

The specific hardware trigger sources may differ by camera models.

Steps:

1. Click **Acquisition Control > Trigger Selector**.
2. Select **Frame Burst Start** or **Line Start** as **Trigger Selector**, and **On** as **Trigger Mode**.
3. Select specific lines as **Trigger Source** according to actual demands.

**NOTE**

Here we take Line 0 as trigger source as an example. Refer to the camera you got for the actual condition.

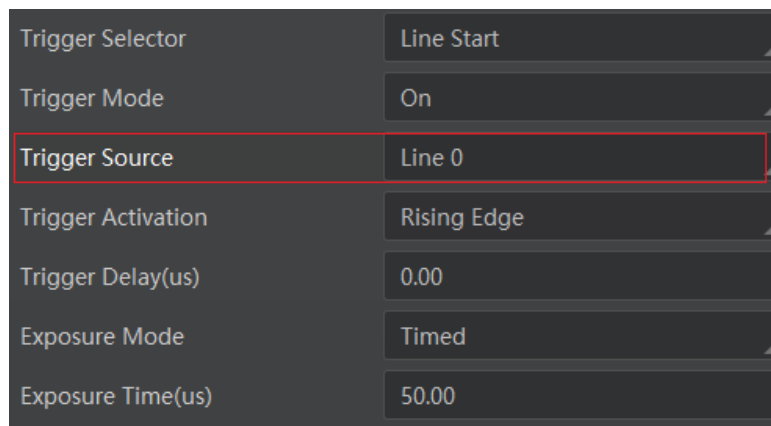

Figure 7-6 Set Hardware Trigger

When selecting bi-directional configurable line as the hardware trigger source, you need to make sure that its line mode is input. Go to **Digital IO Control**, select specific line as **Line Selector**, and **Input** as **Line Mode**.

 **NOTE**

Here we take Line 2 as an example to introduce how to set bi-directional configurable line as the hardware trigger source. Refer to the camera you got for the actual condition.

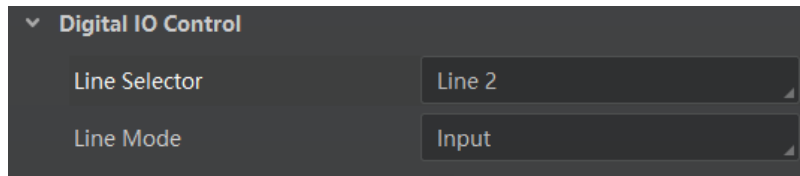

Figure 7-7 Set Line 2 as Input Signal

You can also set the signal type for the selected bi-directional configurable line. Go to **Digital IO Control**, and set **Line Format** according to actual demands.

- **SingleEnded**: It can receive single-ended input signal.
- **Differential**: It can receive TTL & LVTTTL standard input signal.

 **NOTE**

- When selecting **Differential** as **Line Format**, the camera supports 5/12/24 VDC differential signal input.
- The line format function may differ by camera models.

 **WARNING**

You need to select line format according to the external device connected. Otherwise, I/O may be damaged.

7.5.3 Set Shaft Encoder Control

If the camera enables the line trigger, you can select **Encoder Module Out** as trigger source. At this time, the camera will receive signal A and signal B with phase difference. After internal computing, the outputted signal can be used as camera's trigger signal. The function demonstration of shaft encoder module is shown below.

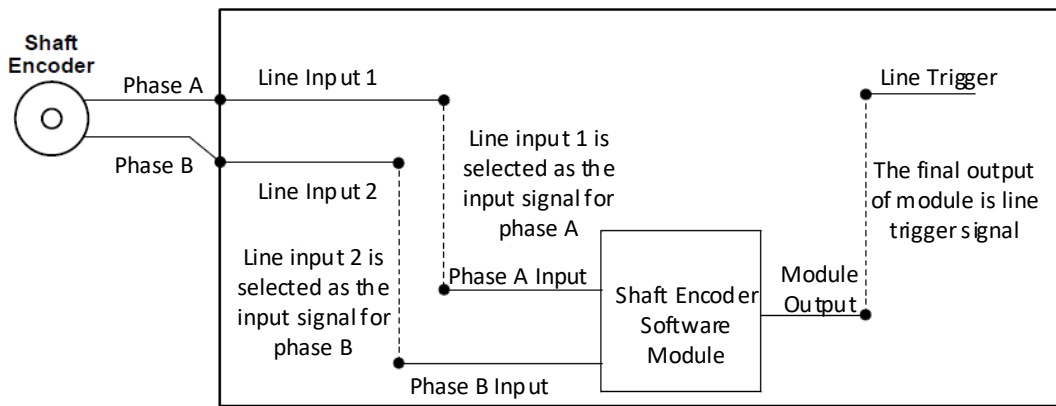

Figure 7-8 Function Demonstration

The advantages of shaft encoder are as follows:

- Encoder output pulse frequency is proportional to rotating speed.
- The output pulse acts as a trigger signal for line scan camera.
- Synchronize acquisition speed and sample movement of camera.
- Non-uniform motion can also be a perfect match.
- A trigger signal can be set as acquiring multiple lines or multiple frames with adjustable ratio.

Follow steps below to set shaft encoder control.

Steps:

1. Click **Encoder Control**, and set **Encoder Source A** and **Encoder Source B** according to actual demands.
2. Set **Encoder Trigger Mode**.
 - **Any Direction** means that both forward and backward direction will trigger.
 - **Forward Only** mean that only forward direction will trigger.
 - **Backward Only** mean that only backward direction will trigger.

NOTE

The 2K camera outputs one signal in one source signal, and the 4K and 8K cameras output four signal in one source signal.

3. (Optional) Regarding MV-CL021-40GM and MV-CL022-40GC cameras, you can set **Encoder Trigger Frequency** to let the camera output multiple signals, including 1 Tick, 2 Tick and 4 Ticks.

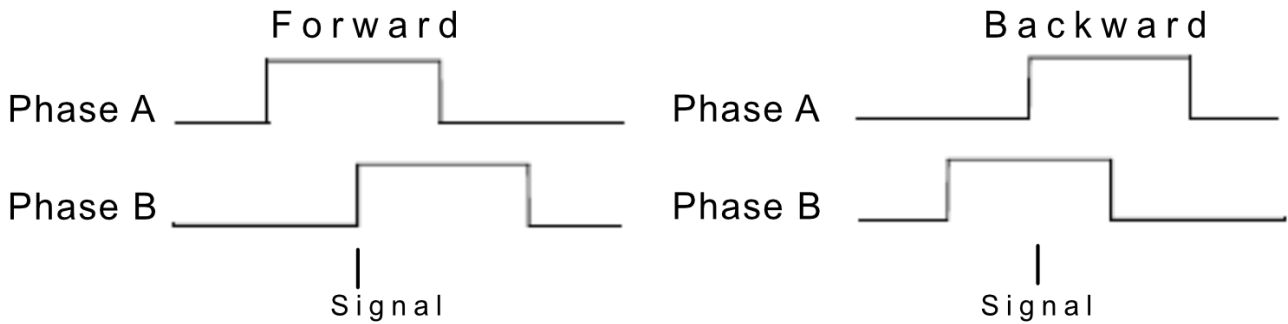

Figure 7-9 Process Logic of 1 Tick

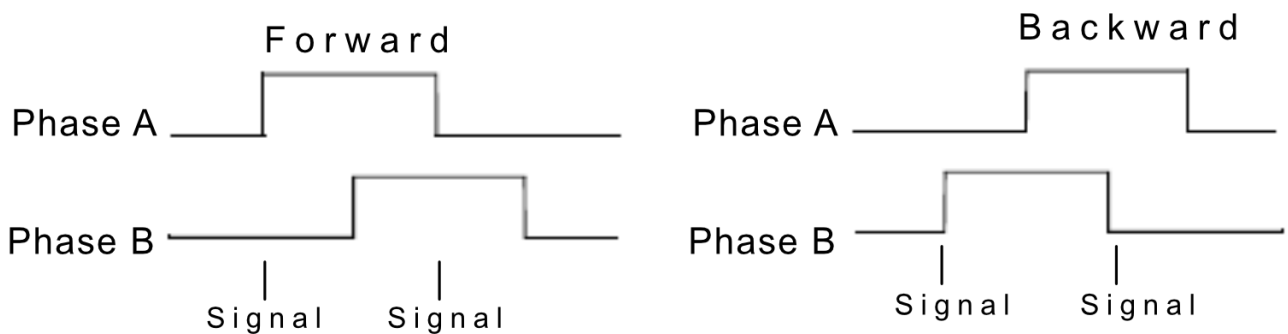

Figure 7-10 Process Logic of 2 Ticks

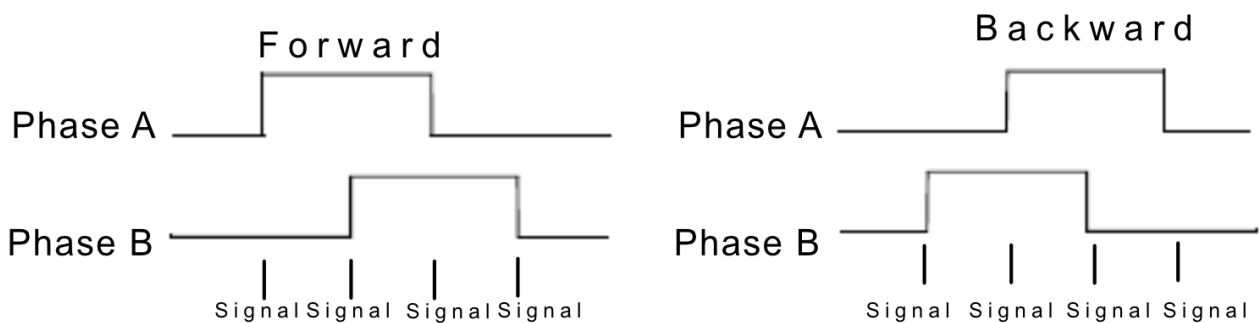

Figure 7-11 Process Logic of 4 Ticks

 **NOTE**

For other camera models, **Encoder Trigger Frequency** outputs 4 signals by default.

4. Set **Encoder Counter Mode**.

- **Ignore Direction** means that both forward and backward direction will count.
- **Follow Direction** means that the forward direction is valid, and **Encode Counter** will increase.
- **Backward Direction** means that the backward direction is valid, and **Encode Counter** will increase.

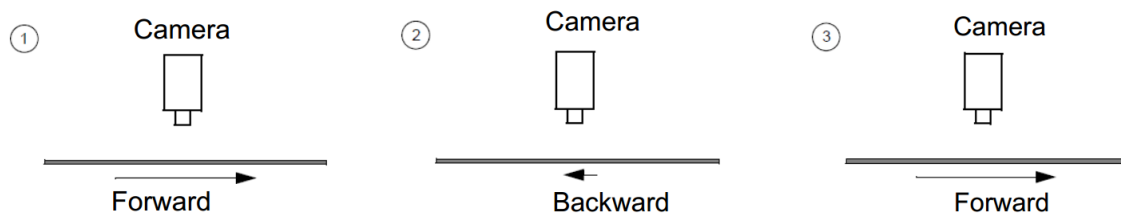

Figure 7-12 Counter Description

5. (Optional) Set max. counter value (0 to 32767) in **Encoder Counter Max**.

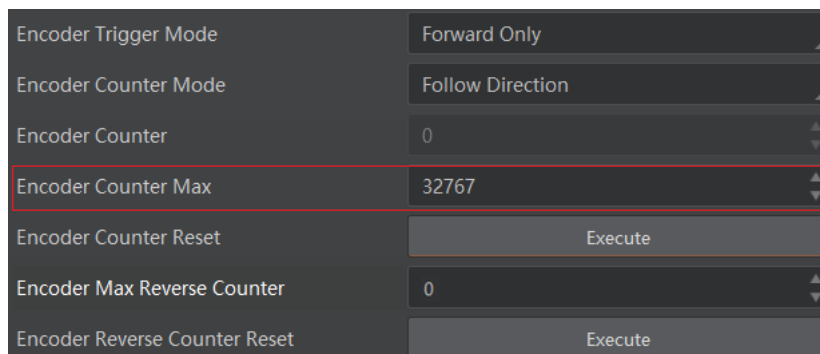

Figure 7-13 Set Encoder Counter Max

NOTE

After reaching the max. value, it will be cleared automatically or you can clear manually by clicking **Encoder Counter Reset**.

6. (Optional) Set **Encoder Max Reverse Counter** to avoid outputting images if the object moves backward accidentally during measurement, and click **Execute** in **Encoder Reverse Counter Reset** to let the camera to output images again.

7.5.4 Set Frequency Converter Control

If the camera enables the frame trigger or the line trigger, you can select **Frequency Converter** as trigger source. The hardware signal trigger or shaft encoder control signal can be converted into the signal frequency of frame trigger or line trigger by camera's frequency converter module.

The frequency converter module includes **PreDivider**, **Multiplier** and **PostDivider**. The signal after being processed by these 3 modules is the camera's final trigger signal.

● PreDivider

The input signal first enters the PreDivider module, which reduces source signal frequency via integer division, and then the signal is sent to the Multiplier module.

The PreDivider module reduces periodic jitter on the input signal, and signals above 100 kHz must go through the PreDivider module to reduce the frequency for the Multiplier can only receive signals in the range of 10 Hz to 100 kHz frequency range. The periodic jitter of shaft encoder signal is accepted.

● Multiplier

After the signal is processed by the PreDivider, it is sent to the Multiplier. The Multiplier multiplies the signal by an integer to increase its signal frequency, and then the signal is sent to the PostDivider.

Parameter can be set as rising or falling edge. If a rising edge is set, each rising edge of the signal coming from the PreDivider will be locked to match the signal of the rising edge, and vice versa.

During this process, make sure do not increase signal frequency via too larger multipliers to avoid trigger signal frequency beyond the max. line rate of the camera. Even if a smaller multiplier is selected, an excessively high frequency may be generated in the frequency adjustment, exceeding the max. line rate of the camera.

● PostDivider

PostDivider reduces signal frequency via an integer factor, and uses the newly generated frequency signal as the camera's trigger signal.

Follow steps below to set frequency converter control.

Steps:

1. Click **Frequency Converter Control**, and select specific line or **Encoder Module Out** as **Input Source** according to actual demands.
2. Set **Rising Edge** or **Falling Edge** as **Signal Alignment** according to actual demands.
3. Set **PreDivider**, **Multiplier** and **PostDivider**.

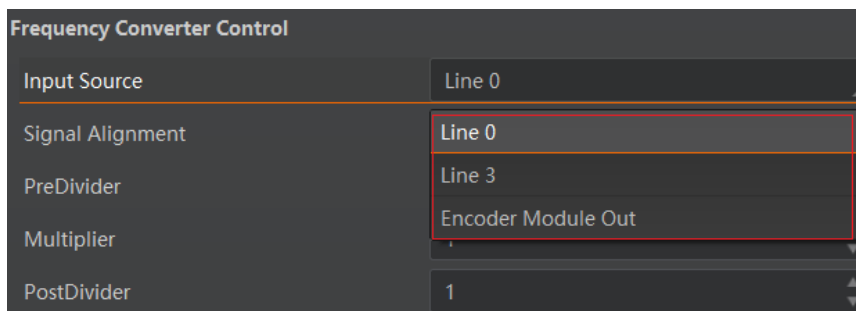

Figure 7-14 Set Frequency Converter Control

7.5.5 View Trigger Line Rate

NOTE

Parameters of trigger line rate and resulting trigger line rate may differ by camera models.

- **Trigger Line Rate:** It refers to the external trigger raw line rate after filtering, and it only involves external trigger signals.

- **Resulting Trigger Line Rate:** It refers to the external trigger frequency cameras received after the external trigger raw line rate is calculated via frequency converter control. It only involves external trigger signals.

You need to select external trigger sources as **Input Source** to display specific values in **Trigger Line Rate** and **Resulting Trigger Line Rate**. If **N/A** is selected as **Input Source**, these two parameter values will be 0.

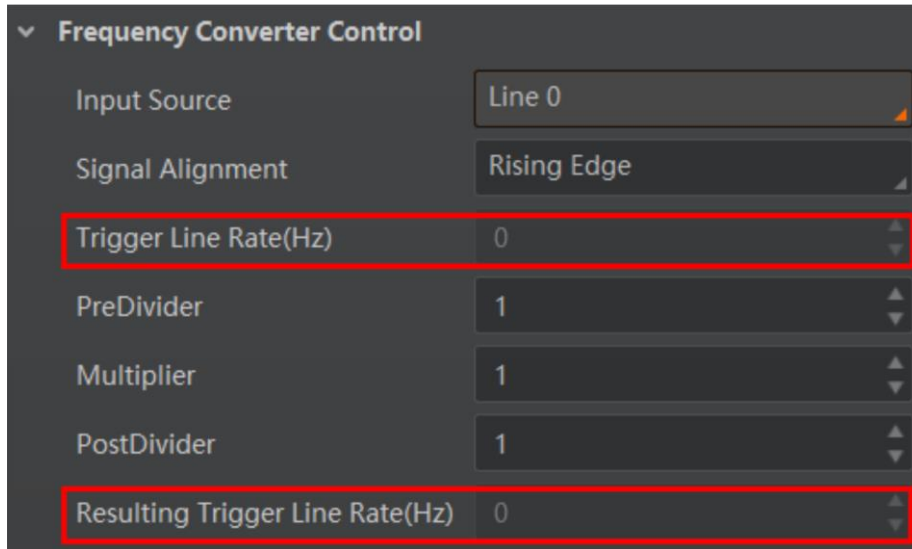

Figure 7-15 View Trigger Line Rate

NOTE

Make sure that line trigger is enabled and input source value of frequency converter control and trigger source value of acquisition control is the same before viewing trigger line rate.

7.5.6 Set Action Command Trigger

NOTE

The action command function may differ by camera models.

The action command allows you to execute actions on multiple cameras at roughly the same time by using a single broadcast protocol message.

NOTE

- The action command function is available only with client software version of V3.1.0 and higher.
- If you want to send action commands that are executed in multiple cameras at exactly the same time, it is recommended to enable **Gev IEEE 1588** first by clicking **Transport Layer Control > Gev IEEE 1588**.

Steps:

1. Click **Tool > GigE Vision Action Command**.
2. Select **Network Interfaces** to set the subnet that the command to be sent to.
3. Enter the **Device Key**, **Group Key**, and **Group Mask**.

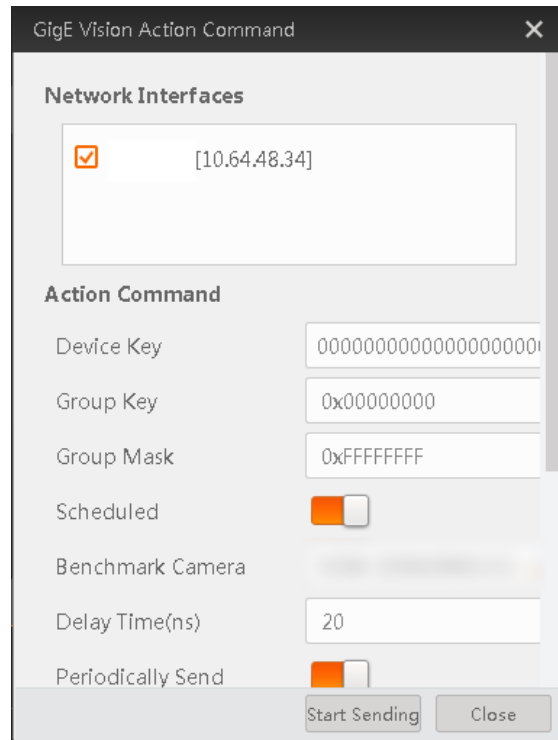



Figure 7-16 Set Action Command

 **NOTE**

The specific contents entered in **Device Key** and **Group Key** should be the same with those in **Action Device Key** and **Action Group Key** of the **Action Control** feature. The bitwise AND operation of the **Group Mask** against the **Action Group Mask** feature should results in non-zero.

4. Enable **Scheduled**.
5. Click  in **Benchmark Camera** to select one camera as benchmark camera. Once benchmark camera is selected, other cameras keep time synchronization with it.
6. (Optional) Enter **Delay Time** according to actual demands.

 **NOTE**

- The delay time should NOT be shorter than the maximum time required to transmit the command across the network.
- When the benchmark camera receives the command, all the cameras will trigger certain actions simultaneously after the specified delay time.

- (Optional) Enable **Periodically Send** to enable the client to send commands periodically, and enter **Sending Interval** according to actual demands.

 **NOTE**

The default value of sending interval is 1000 ms, and its range is from 1 ms to 3600000 ms.

- (Optional) Enable **Request Acknowledgement** to display the acknowledgement messages.

 **NOTE**

Up to 50 messages can be displayed. Once the message quantity exceeds 50, the earliest message will be automatically deleted.

- Click **Start Sending**.

7.5.7 Set Free Trigger

If the camera enables the frame trigger or line trigger, you can select **Anyway** as trigger source to enable the free trigger. At this time, the camera can receive signals of all trigger sources.

Steps:

- Click **Acquisition Control > Trigger Selector**.
- Select **Frame Burst Start** or **Line Start** as **Trigger Selector**, and **On** as **Trigger Mode**.
- Select **Anyway** as **Trigger Source**.

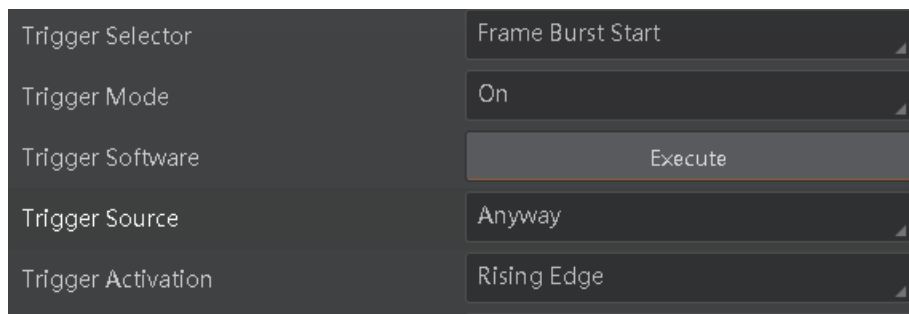

Figure 7-17 Set Free Trigger

7.6 Trigger Related Parameters

 **NOTE**

The configurable trigger related parameters may differ by camera models.

If the camera enables the frame trigger or line trigger, you can set trigger related parameters, including acquisition burst frame count, trigger activation, trigger delay, trigger cache, and trigger debouncer. Different trigger modes can set various trigger parameters, and their relation is shown below.

- If the frame trigger is enabled, the relation between trigger source and trigger related parameters is shown below.

Table 7-4 Trigger Source and Trigger Related Parameters

Trigger Source Parameters	Software Trigger	Hardware Trigger	Frequency Converter Control	Free Trigger
Acquisition Burst Frame Count	√	√	√	√
Trigger Activation	×	√	√	√
Trigger Delay	√	√	√	√
Frame Trigger Cache	√	√	√	√
Trigger Debouncer	×	√	√	√

- If the line trigger is enabled, the relation between trigger source and trigger related parameters is shown below.

Table 7-5 Trigger Source and Trigger Related Parameters

Trigger Source Parameters	Hardware Trigger	Shaft Encoder Control	Frequency Converter Control	Free Trigger
Trigger Activation	√	√	√	√
Trigger Delay	√	√	√	√
Line Trigger Cache	√	√	√	√
Trigger Debouncer	√	×	×	√

7.6.1 Acquisition Burst Frame Count

If the camera enables the frame trigger, you can set the acquisition burst frame count. Click **Acquisition Control > Acquisition Burst Frame Count**, and enter **Acquisition Burst Frame Count** according to actual demands. Its range is from 1 to 1023.

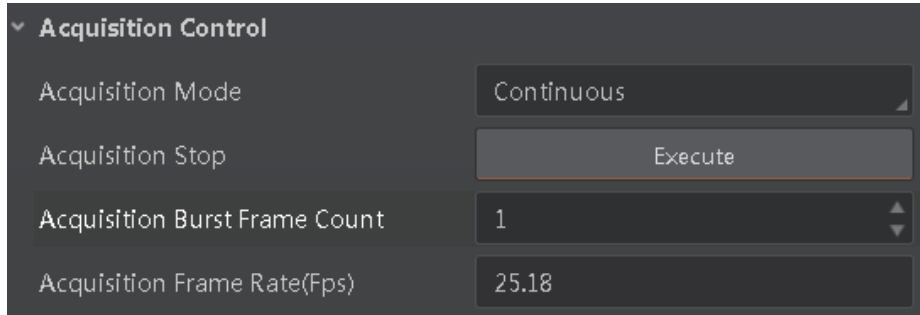

Figure 7-18 Set Burst Frame Count

When **Acquisition Burst Frame Count** is 1, it is in single frame trigger mode. When **Acquisition Burst Frame Count** is larger than 1, it is in multi-frame trigger mode. If **Acquisition Burst Frame Count** is n and when inputting 1 trigger signal, the camera stops acquiring images after exposing n times and outputs n frame images. The sequence diagram of burst frame count is shown below.

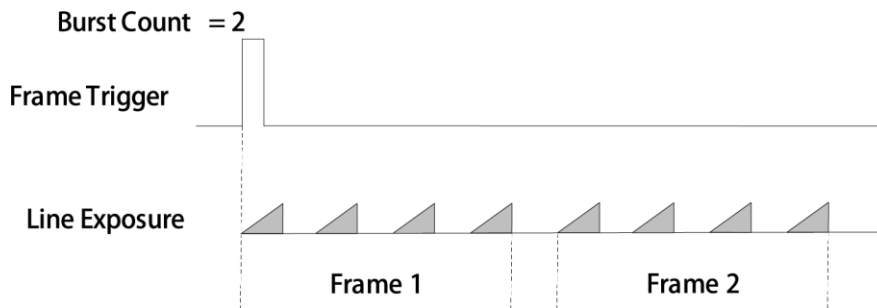

Figure 7-19 Sequence Diagram

NOTE

The sequence diagram above uses rising edge as trigger activation, and the camera's height parameter is 4.

7.6.2 Trigger Activation

NOTE

The specific trigger activation parameters may differ by camera models.

The camera supports trigger acquisition in the rising edge, falling edge, any edge, level high or level low of the external signal. The principle and parameter of trigger activation are shown below.

Table 7-6 Trigger Activation Principle and Parameter

Trigger Activation	Parameter	Parameter Value	Principle
Rising Edge	Acquisition Control > Trigger Activation	Rising Edge	The camera receives signal and triggers when the level signal sent by the external device is in the rising edge.

Trigger Activation	Parameter	Parameter Value	Principle
Falling Edge	Acquisition Control > Trigger Activation	Falling Edge	The camera receives signal and triggers when the level signal sent by the external device is in the falling edge.
Any Edge	Acquisition Control > Trigger Activation	Any Edge	The camera receives signal and triggers when the level signal sent by the external device is in the rising edge or falling edge.
Level High	Acquisition Control > Trigger Activation	Level High	The camera receives signal and triggers when the level signal sent by the external device is in the level high.
Level Low	Acquisition Control > Trigger Activation	Level Low	The camera receives signal and triggers when the level signal sent by the external device is in the level low.

The setting method for trigger activation is different in frame trigger and line trigger.

- **Set Trigger Activation in Frame Trigger**

Go to **Acquisition Control**, and set **Trigger Activation** according to actual demands.

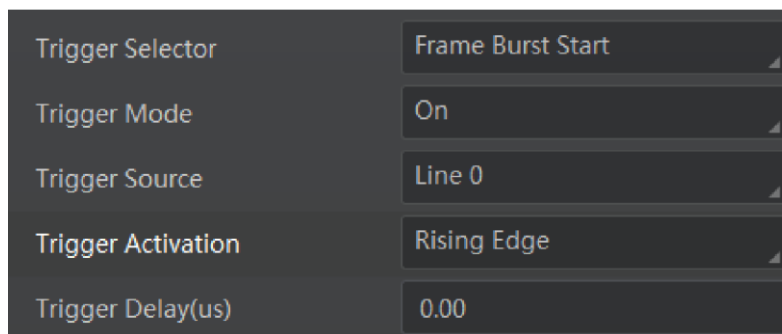

Figure 7-20 Edge Trigger in Frame Trigger

- When rising edge or falling edge is selected as **Trigger Activation**, you can set **Trigger Delay**.
- When level high or level low is selected as **Trigger Activation**, you can set **Trigger Partial Close**. True means that images after complement is outputted after the level trigger ends, and false means that images output according to the settings of the frame timeout after the level trigger ends.

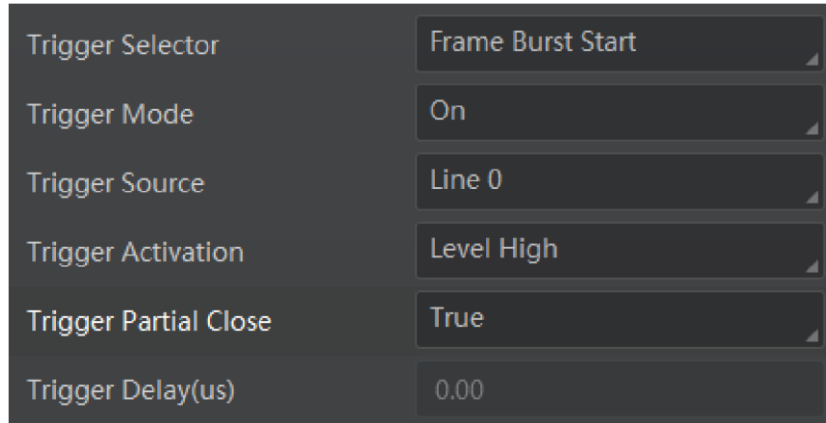

Figure 7-21 Level Trigger in Frame Trigger

- **Set Trigger Activation in Line Trigger**

In the line trigger mode, the trigger activation is related with **Exposure Mode**.

- When **Timed** is selected as **Exposure Mode**, you can select **Rising Edge** or **Falling Edge** as **Trigger Activation**, and **Exposure Auto** and **Exposure Time** determine the exposure time.
- When **Trigger Width** is selected as **Exposure Mode**, you can select **Level Low** or **Level High** as **Trigger Activation**, and exposure time is determined by the duration of the level signal only.

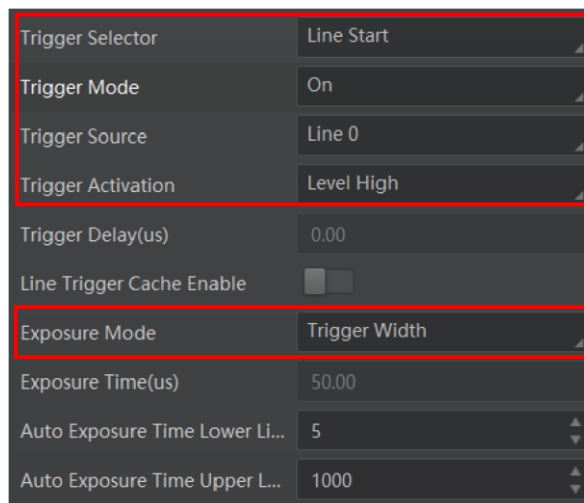

Figure 7-22 Trigger Width as Exposure Mode

 **NOTE**

The trigger width function may differ by camera models.

7.6.3 Trigger Delay

The trigger delay function allows the camera to add a delay between the receipt of trigger signal and the moment the trigger becomes active. Its sequence diagram is shown below.

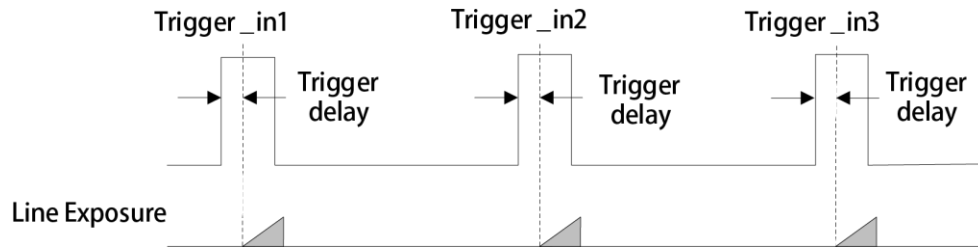

Figure 7-23 Signal Delay Sequence Diagram

You can click **Acquisition Control > Trigger Delay**, and enter **Trigger Delay**.

Trigger Mode	On
Trigger Source	Line 0
Trigger Activation	Rising Edge
Trigger Delay(us)	16000000.00
Exposure Mode	Timed
Exposure Time(us)	50.00
Exposure Auto	Off

Figure 7-24 Set Trigger Delay

NOTE

The sequence diagram above uses rising edge as trigger activation.

7.6.4 Frame/Line Trigger Cache

NOTE

The frame/line trigger cache function may differ by camera models.

If the camera enables the frame trigger or line trigger, it has the frame/line trigger cache function. During the triggering process, if the camera receives new trigger signal, it will save and process the signal if you enable this function. Trigger cache enable can save up to 3 trigger signals.

The setting method for trigger cache is different in frame trigger and line trigger.

● Set Trigger Cache in Frame Trigger

Steps:

1. Click **Acquisition Control > Trigger Selector**.
2. Select **Frame Burst Start** as **Trigger Selector**, and **On** as **Trigger Mode**.
3. Enable **Trigger Cache Enable**.

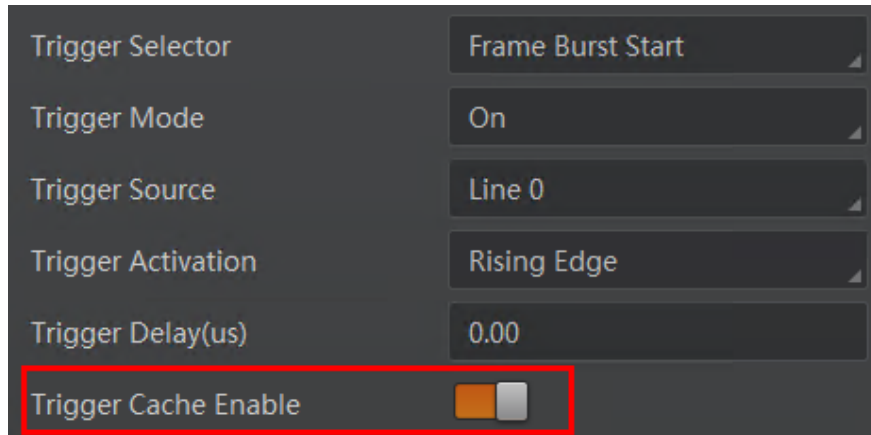

Figure 7-25 Set Trigger Cache in Frame Trigger

If the camera receives the 1st trigger signal first, and the camera receives the 2nd trigger signal during processing the 1st trigger signal.

- Disable Trigger Cache Enable: the 2nd trigger signal will be filtered without processing.

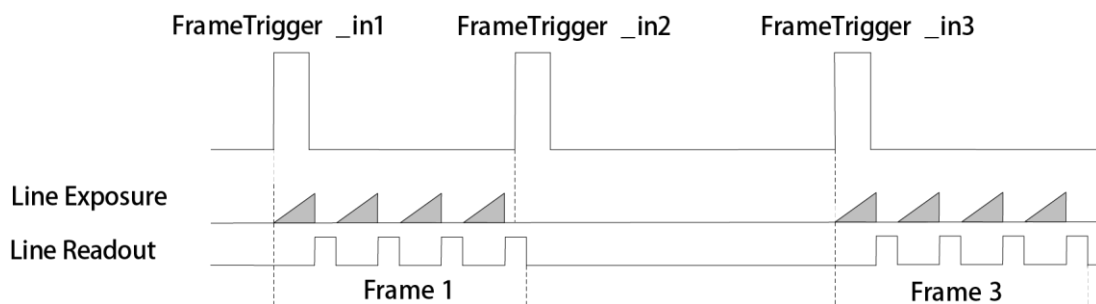

Figure 7-26 Second Frame Filtered

- Enable Trigger Cache Enable: the 2nd trigger signal will be saved.

If the 1st frame image's exposure time of the 2nd trigger signal is not earlier than the camera's last frame creation time of the 1st trigger signal, and then the 2nd trigger signal's 1st frame image is created normally.

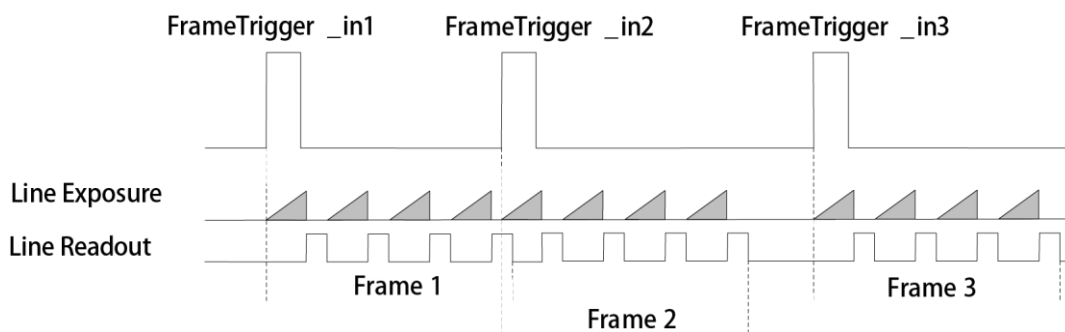

Figure 7-27 Second Frame Created Normally

If the 1st frame image's exposure time of the 2nd trigger signal is earlier than the camera's last frame creation time of the 1st trigger signal, and then the camera will delay this exposure time.

Thus making sure this exposure time is not earlier than the camera's last frame creation time of the 1st trigger signal.

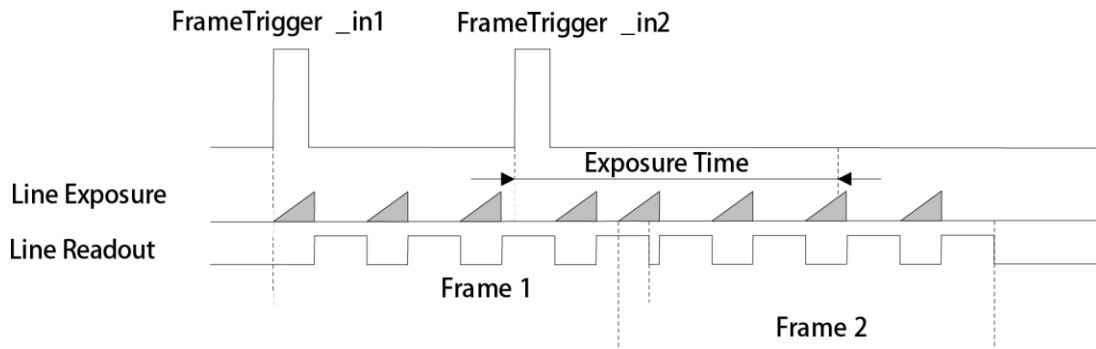

Figure 7-28 Sequence Diagram

NOTE

The three sequence diagrams above use rising edge as trigger activation, and the camera's height parameter is 4.

● Set Trigger Cache in Line Trigger

Steps:

1. Click **Acquisition Control > Trigger Selector**.
2. Select **Line Start** as **Trigger Selector**, and **On** as **Trigger Mode**.
3. Enable **Line Trigger Cache Enable**.

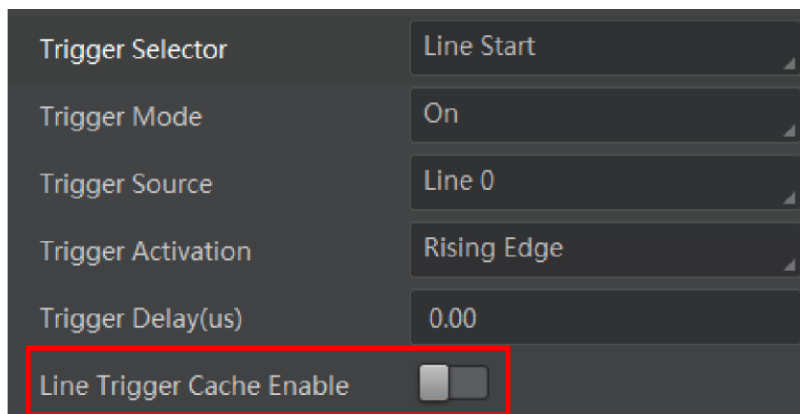

Figure 7-29 Set Trigger Cache in Line Trigger

7.6.5 Trigger Debouncer

The trigger debouncer function allows the camera to filter out unwanted short external trigger signal that is input to the camera. Its sequence diagram is shown below.

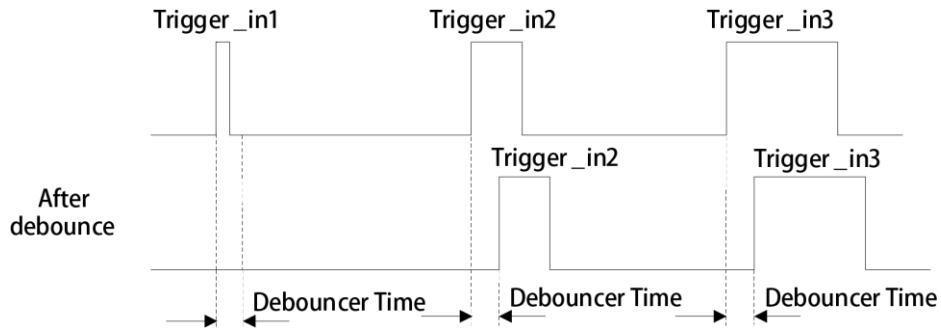

Figure 7-30 Trigger Debouncer Sequence Diagram

Click **Digital IO Control** > **Line Debouncer Time**, and set **Line Debouncer Time** according to actual demands.

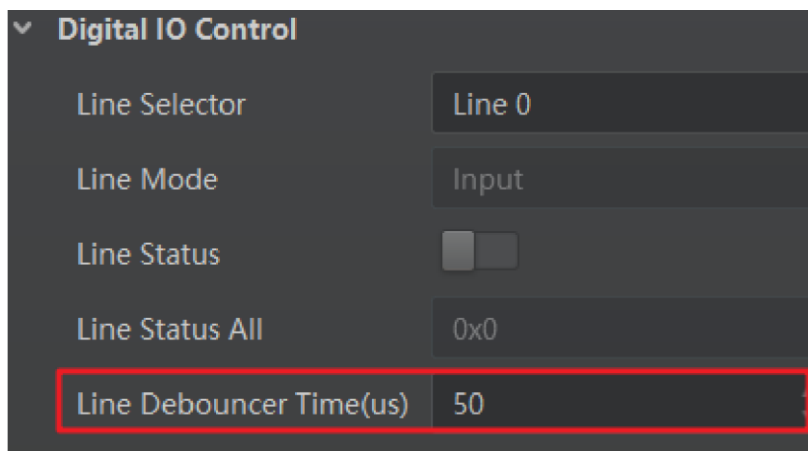

Figure 7-31 Set Line Debouncer Time

 **NOTE**

- When the configured debouncer time is larger than trigger signal time, and the trigger signal will be ignored.
- The unit of line debouncer time may differ by device models.
- The sequence diagram above uses rising edge as trigger activation.

Chapter 8 I/O Output

8.1 Select Output Signal

NOTE

The selectable output signal line may differ by camera models.

The camera has multiple differential output lines or bi-directional configurable lines. The method of setting bi-directional configurable line as output line as follows:

Steps:

1. Click **Digital IO Control**, and select specific line as **Line Selector**.
2. Set **Strobe** as **Line Mode**.
3. (Optional) Set **Line Format** according to actual demands. Differential stands for the differential signal.

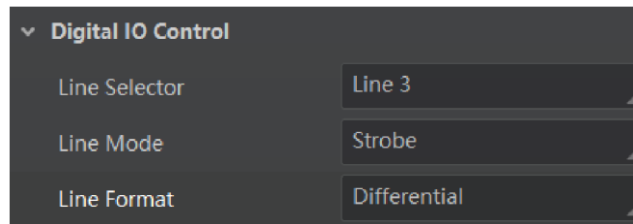

Figure 8-1 Select Output Signal

NOTE

- The line format function may differ by camera models.
- If a bi-directional configurable line signal is selected as **Line Selector** and **Line Mode** is **Input** currently, but you cannot set **Strobe** as **Line Mode**. The reason is that the bi-directional configurable line signal is selected as trigger source in one of line trigger/frame trigger/shaft encoder control/ frequency converter control settings. You should set other line signals as trigger source in line trigger/frame trigger/shaft encoder control/ frequency converter control settings all.

8.2 Set Output Signal

The output signal of the camera is switch signal, which is used to control external devices such as alarm light, light source and PLC. There are two ways to achieve output signal, including line inverter and strobe signal.

8.2.1 Enable Line Inverter

Go to **Digital IO Control**, and enable **Line Inverter**.

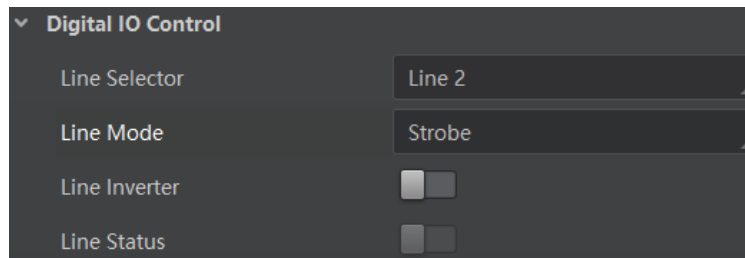

Figure 8-2 Enable Level Inverter

NOTE

The **Line Inverter** parameter is disabled by default.

8.2.2 Enable Strobe Signal

The strobe signal is used to directly output signal to external devices when the camera's event source occurs. The camera supports synchronously outputting signals when it outputs one frame or one line image.

- If you need to let the camera output signals when it outputs one frame image, follow steps below to set it.

Steps:

1. Click **Digital IO Control**, and set **Exposure Start Active** as **Line Source**.
2. Select **Frame Mode** as **Strobe Source Selector**.
3. Enable **Strobe Enable**.

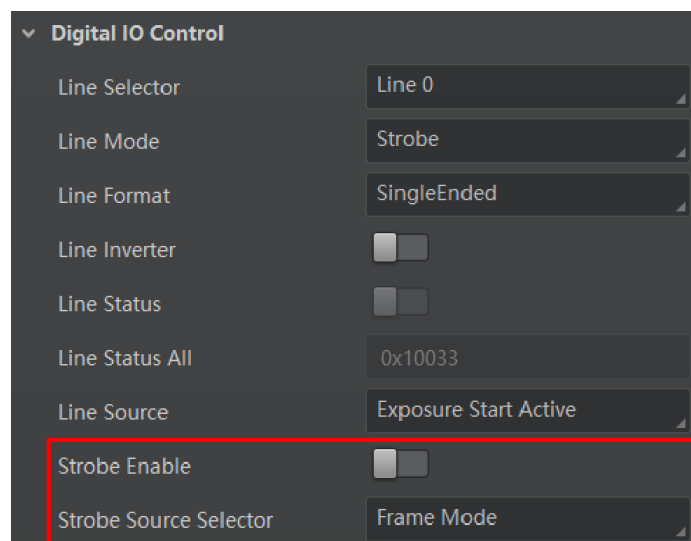

Figure 8-3 Set Frame Mode

- If you need to let the camera output signals when event sources occur that are corresponding to each line image, follow steps below to set it.

Steps:

1. Click **Digital IO Control**, and select **Line Mode** as **Strobe Source Selector**.
2. Set **Line Source** according to actual demands.
3. Enable **Strobe Enable**.

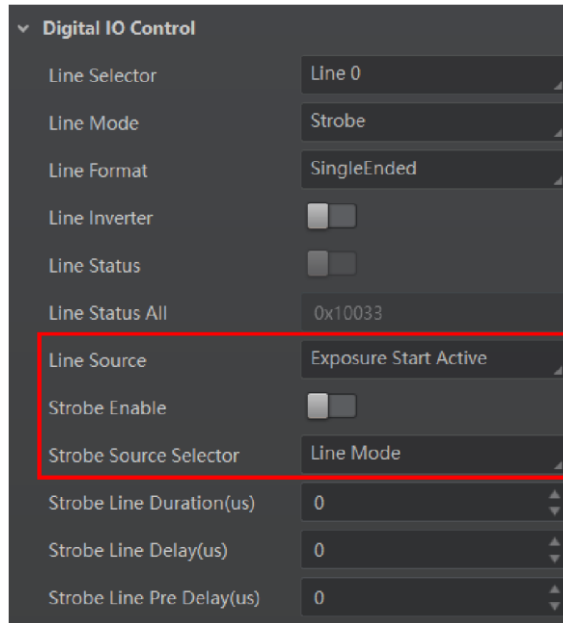

Figure 8-4 Set Line Mode

When selected event sources occur, one event information will be created, and the camera will output one strobe signal at the same time. Refer to the table below for detailed event source description.

 **NOTE**

The specific event source may differ by camera models.

Table 8-1 Event Source Description

No.	Name	Description
1	Exposure Start Active	The camera outputs signals to external devices when it starts exposure.
2	Acquisition Start Active	The camera outputs signals to external devices when it starts acquiring images.
3	Acquisition Stop Active	The camera outputs signals to external devices when it stops acquiring images.
4	Frame Burst Start Active	The camera outputs signals to external devices when frame burst starts.

No.	Name	Description
5	Frame Burst End Active	The camera outputs signals to external devices when frame burst stops.
6	Soft Trigger Active	The camera outputs signals to external devices when software trigger starts.
7	Hard Trigger Active	The camera outputs signals to external devices when hardware trigger starts.
8	Counter Active	The camera outputs signals to external devices when counter trigger starts.
9	Timer Active	The camera outputs signals to external devices when timer trigger starts.

Regarding Counter And Timer Control, you can refer the table below for details.

Table 8-2 Description of Counter And Timer Control

Parameter	Read/Write	Description
Counter Selector	Read and write	It selects counter source. Counter 0 is available only at present.
Counter Event Source	Read and write	It selects the signal source of counter trigger. It is disabled by default.
Counter Reset Source	Read and write	It selects the signal source of resetting counter. Software is available only. It is disabled by default.
Counter Reset	Write is available under certain condition	It resets counter and it can be executed when selecting Software as Counter Reset Source .
Counter Value	Read and write	It is the counter value with the range of 1 to 1023.
Counter Current Value	Read only	It displays the number of executed external trigger.

When selecting **Line Mode** as **Strobe Source Selector**, you can also set duration, delay and pre delay for outputted signal.

- **Set Strobe Line Duration**

After enabling strobe signal, you can set its duration. Click **Digital IO Control > Strobe Line Duration**, and enter **Strobe Line Duration**.

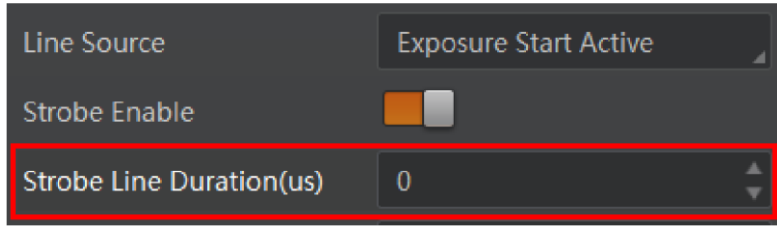

Figure 8-5 Set Strobe Line Duration

 **NOTE**

When the **Strobe Line Duration** value is 0, the strobe duration is equal to the exposure time. When the **Strobe Line Duration** value is not 0, the strobe duration is equal to **Strobe Line Duration** value.

● **Set Strobe Line Delay**

The camera supports setting strobe line delay to meet actual demands. When exposure starts, the strobe output doesn't take effect immediately. Instead, the strobe output will delay according to the strobe line delay setting.

Click **Digital IO Control > Strobe Line Delay**, and enter **Strobe Line Delay** according to actual demands.

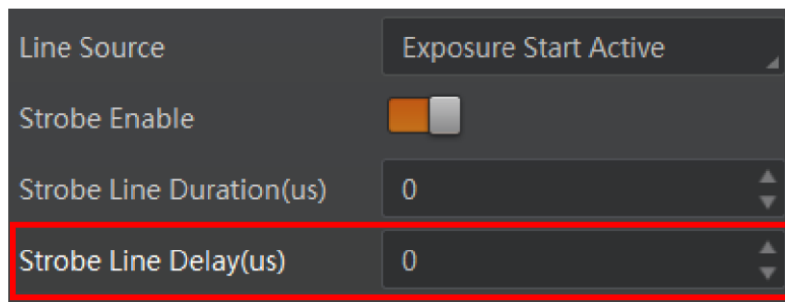

Figure 8-6 Set Strobe Line Delay

The sequence diagram of strobe line delay is shown below.

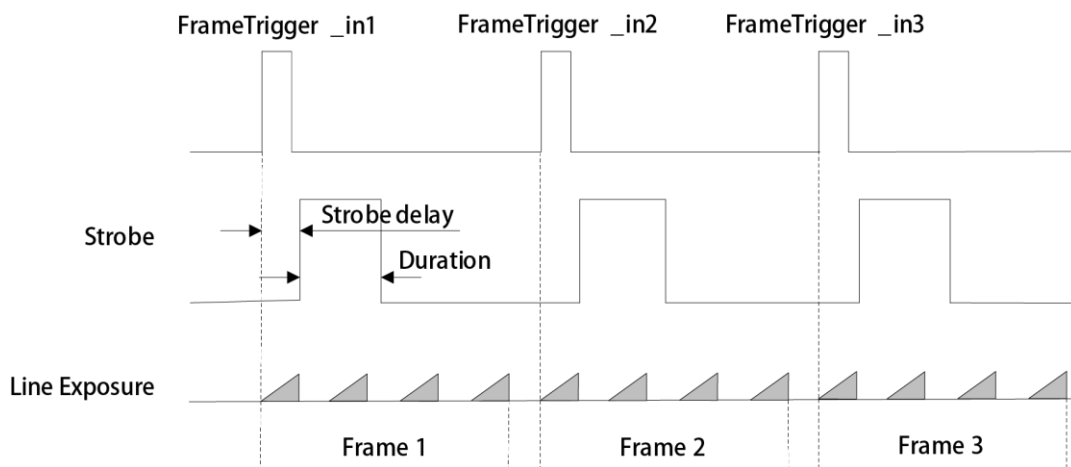

Figure 8-7 Sequence Diagram of Strobe Line Delay

 **NOTE**

The camera's height parameter is 4 in the sequence diagram above.

- **Set Strobe Line Pre Delay**

The camera also supports the function of strobe line pre delay, which means that the strobe signal takes effect early than exposure. This function is applied to the external devices that have slow response speed.

Click **Digital IO Control > Strobe Line Pre Delay**, and enter **Strobe Line Pre Delay** according to actual demands.

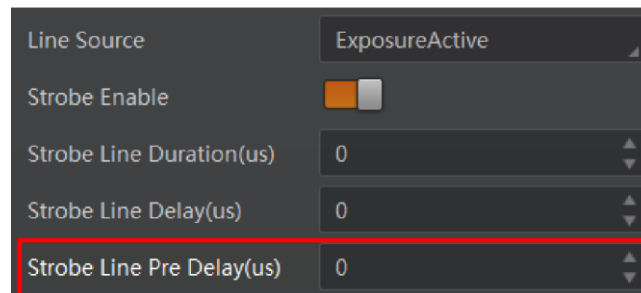

Figure 8-8 Set Strobe Line Pre Delay

The sequence diagram of strobe line pre delay is shown below.

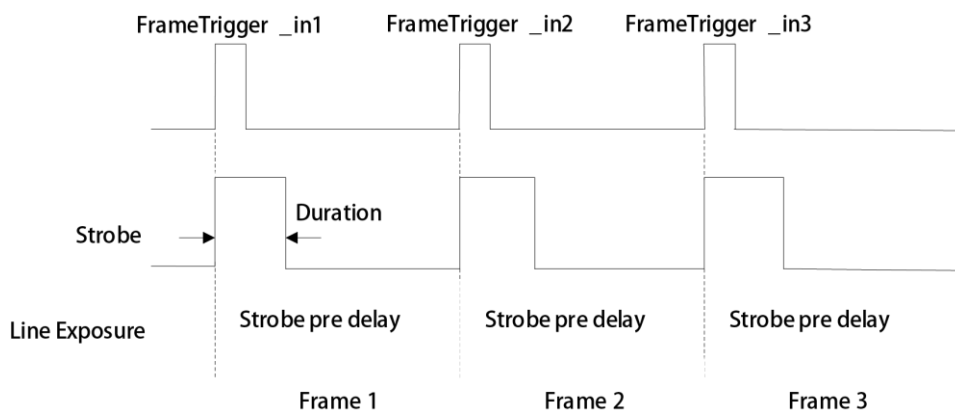

Figure 8-9 Sequence Diagram of Strobe Line Pre Delay

 **NOTE**

The camera's height parameter is 4 in the sequence diagram above.

Chapter 9 I/O Electrical Feature and Wiring

9.1 I/O Introduction

The I/O signals of MV-CL021-40GM, MV-CL022-40GC, and MV-CL042-90GM/GC cameras are two differential input signals (Line 0/3), two differential output signals (Line 1/4), and one bi-directional configurable signal (Line 2).

The I/O signals of other camera models are four configurable input or output signals (Line 0/1/3/4). The Line 0/1/3/4 can be set as differential input or differential output according to actual demands.

9.2 I/O Electrical Feature

9.2.1 Differential Input Circuit

The differential input signal in I/O signals supports the single-ended input, and its internal circuit is shown below.

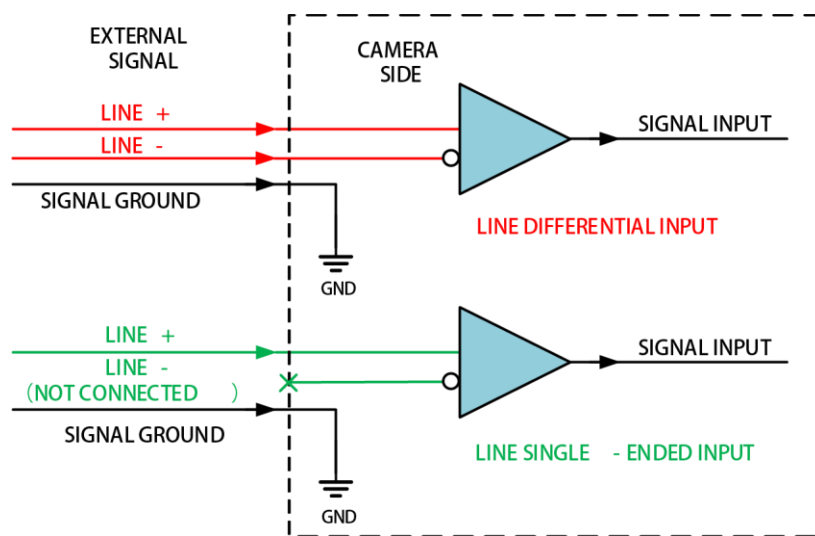

Figure 9-1 Internal Circuit of Differential Input

The RS-422 standard, RS-644 standard and TTL&LVTTTL standard input signal are applied to the differential input.

- RS-422 Standard Input

In order to make sure the normal operation of input circuit, it is required to connect camera's ground signal with external ground signal if the differential input adopts RS-422 standard signal.

RS-422 standard defines the connection of the bus structure, and the inputs of several cameras can be connected to the RS-422. Up to 10 cameras can be connected at the same time, of which only one camera is the master dispenser and other cameras are receivers. The circuit length between

the receiver and the bus should be as short as possible. The bus must have a 120 Ω terminal resistance.

When the camera is the last receiver on the bus structure, the camera's terminal resistance needs to be enabled, and the rest camera's terminal resistance need to be disabled. Multiple terminal resistance should not be enabled on the bus structure, which will reduce signal reliability and may cause damage to the RS-422 device.

- RS-644 Standard Input

If the differential input adopts RS-644 standard signal, the input terminal must enable 120 Ω terminal resistance.

- TTL&LVTTTL Standard Input

If the differential input adopts TTL&LVTTTL standard signal, the input terminal's 120 Ω terminal resistance must be disabled, and its input electrical feature requirement is shown below.

Table 9-1 Electrical Feature Requirement of TTL&LVTTTL

Voltage	Description
0 V to 1 V	Level low
1 V to 3 V	Unstable voltage, and it is not recommended to use it.
3.3 V to 24 V	Level high

9.2.2 Differential Output Circuit

The internal circuit of differential output signal in I/O signals is shown below.

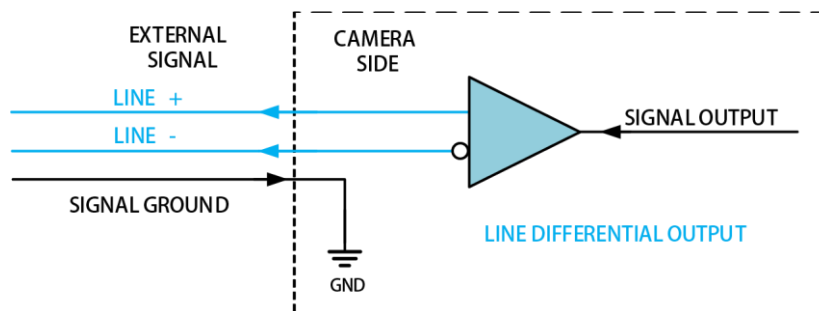

Figure 9-2 Internal Circuit of Differential output

The RS-422 standard and RS-644 standard are applied to the differential output.

- RS-422 Standard Output

In order to make sure the normal operation of output circuit, it is required to connect camera's ground signal with external ground signal. The output interface can be connected to the RS-422 bus structure as a master dispenser.

- RS-644 Standard Output

The camera adopting RS-422 standard output signal cannot directly connect to RS-644 standard. When connecting RS-644 standard output, it is required to add a resistance network in camera's output location. In order to make sure the normal operation of output circuit, it is required to connect camera's ground signal with external ground signal.

9.2.3 Bi-Direction I/O Circuit

The bi-directional I/O can be used as the input signal and output signal, and its internal circuit is shown below.

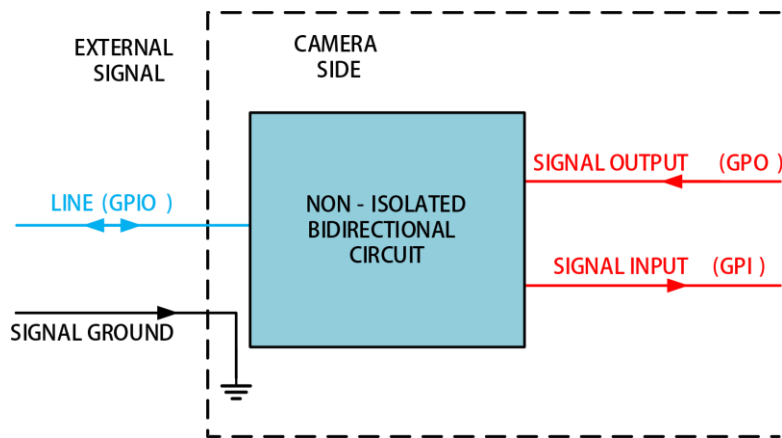

Figure 9-3 Bi-Directional I/O Circuit

- Set Line 2 as Input

Logic 0 input level: 0 VDC to 0.5 VDC (GPIO2 pin).

Logic 1 input level: 1.5 VDC to 30 VDC (GPIO2 pin).

With the condition of 100 Ω and 5 VDC, the logic level and electrical feature of configuring GPIO2 as input are shown below.

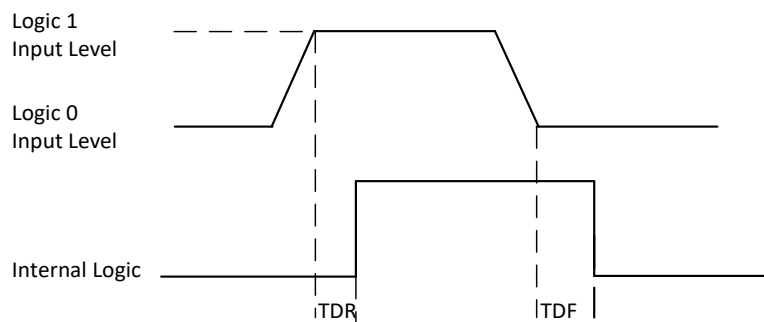

Figure 9-4 Input Logic Level



NOTE

- Make sure the input voltage is not from 1 VDC to 1.5 VDC. The circuit status between the two values is not stable.
- The breakdown voltage is 30 VDC, and keep voltage stable.
- To prevent damage to the GPIO pin, connect GND first and then input voltage in Line 2 pin.

Table 9-2 Electrical Feature of Line 2 Input

Parameter	Symbol	Value
Input Rising Time	TR	0.06 μ s
Input Falling Time	TF	0.016 μ s
Input Rising Delay	TDR	< 1 μ s
Input Falling Delay	TDF	< 1 μ s

- **Set Line 2 as Output**

**NOTE**

The maximum current is 25 mA and the output impedance is 40 Ω .

When the environment temperature is 25 °C (77 °F), the relation among external voltage, resistance and the output low level is shown below.

Table 9-3 Parameter of Output Logic Low Level

External Voltage	External Resistance	VL (GPIO2)
3.3 V	1 K Ω	160 mV
5 V	1 K Ω	220 mV
12 V	1 K Ω	460 mV
24 V	1 K Ω	860 mV
30 V	1 K Ω	970 mV

When the voltage of external resistance (1 K Ω) is pulled up to 5 V, the logic level and electrical feature of configuring GPIO2 as output are shown below.

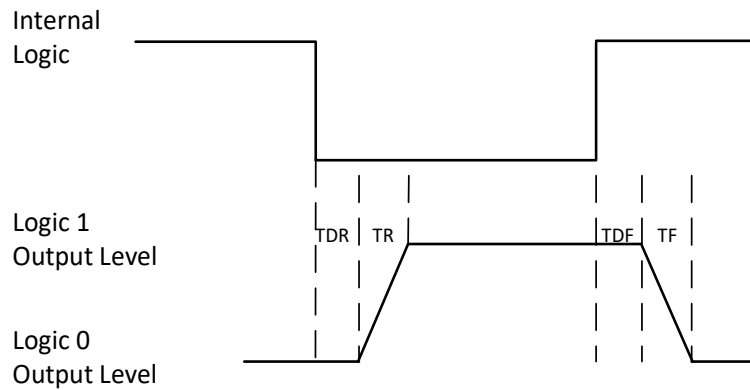

Figure 9-5 Output Logic Level

Table 9-4 Output Electrical Feature

Parameter	Symbol	Value
Output Rising Time	TR	0.06 μ s
Output Falling Time	TF	0.016 μ s
Output Rising Delay	TDR	0 μ s to 4 μ s
Output Falling Delay	TDF	< 1 μ s

9.3 Input Wiring

The camera can receive inputted signals via the hardware trigger to acquire images. The inputted signals include differential signal and single-ended signal. The input wiring has two types according to the camera's pin definitions. The first type of input wiring corresponds to the first type of pin definitions mentioned in **Table 3-1**, and the second type of input wiring corresponds to the second type of pin definitions mentioned in **Table 3-2**.

NOTE

- Make sure that the hardware trigger signals have been configured as input signal.
- Here we take one type of GigE line scan cameras as an example to introduce the input wiring. Refer to the actual camera you got for specific appearance.

9.3.1 First Type of Input Wiring

- **Differential Signal**

NOTE

The wiring may differ by voltages of differential signal sources.

The voltage of the differential signal source is 5 V.

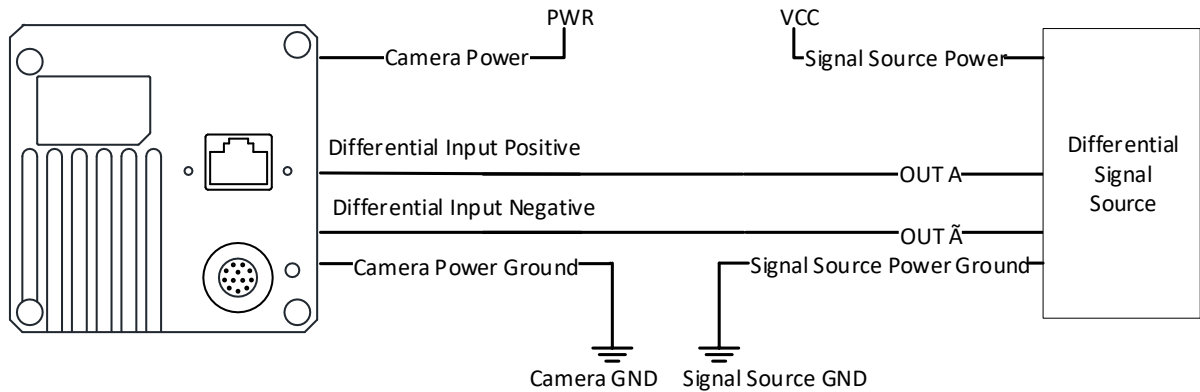

Figure 9-6 5 V Differential Signal Source Outputs Differential Signal

The voltage of the differential signal source is 12 V or 24 V.

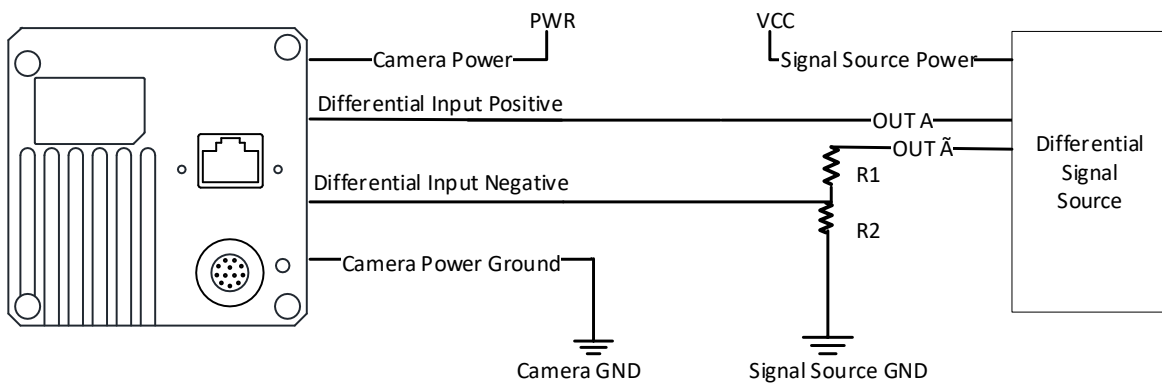

Figure 9-7 12 V and 24 V Differential Signal Sources Output Differential Signal

With different voltages of differential signal sources, the respective resistance values in wiring are also different, as shown below.

Table 9-5 Relation between Voltage and Resistance

VCC	R1	R2
12 V	6.2 K	4.7 K
24 V	18 K	4.7 K

- **Single-Ended Signal**

The single-ended signals that the camera receives can be from the differential signal source or the single-ended signal source.

The VCC of the differential signal source is 5 V, 12 V or 24 V.

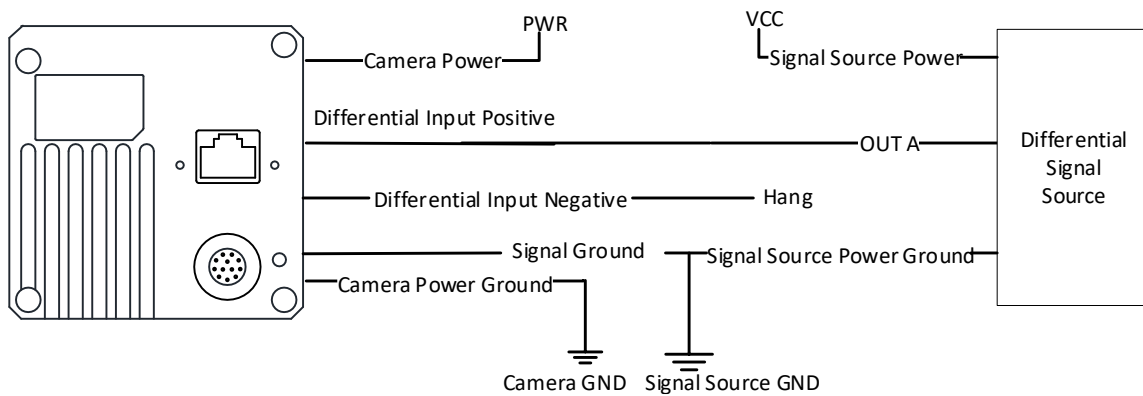

Figure 9-8 Differential Signal Source Outputs Single-Ended Signal

When the PNP single-ended signal source provides signal, and the camera's differential input is used as single-ended input. The VCC of PNP single-ended signal source is 5 V, 12 V or 24V.

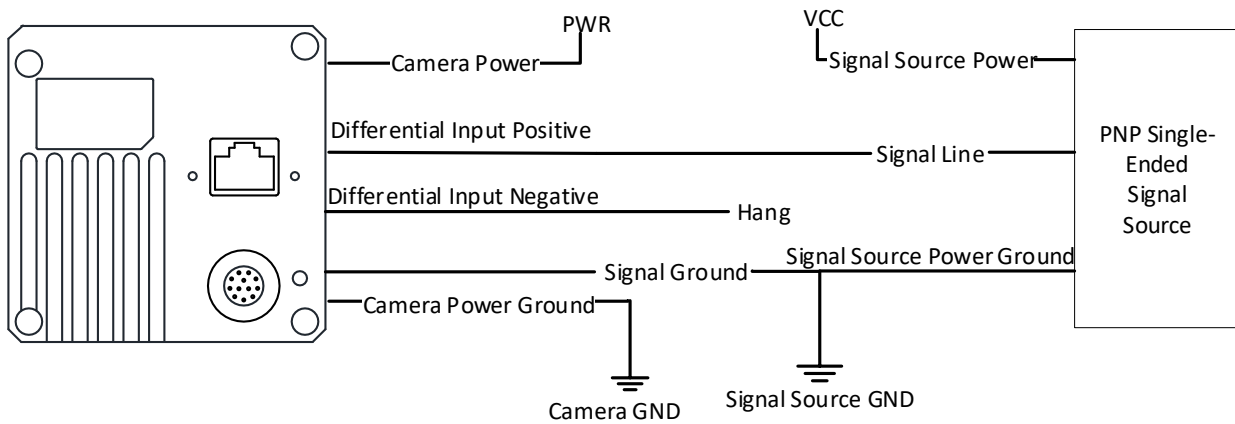

Figure 9-9 PNP Single-Ended Signal Source Connects Differential Input

When the PNP single-ended signal source provides bi-directional I/O to the camera, the wiring is shown below. The VCC of PNP single-ended signal source is 12 V or 24 V.

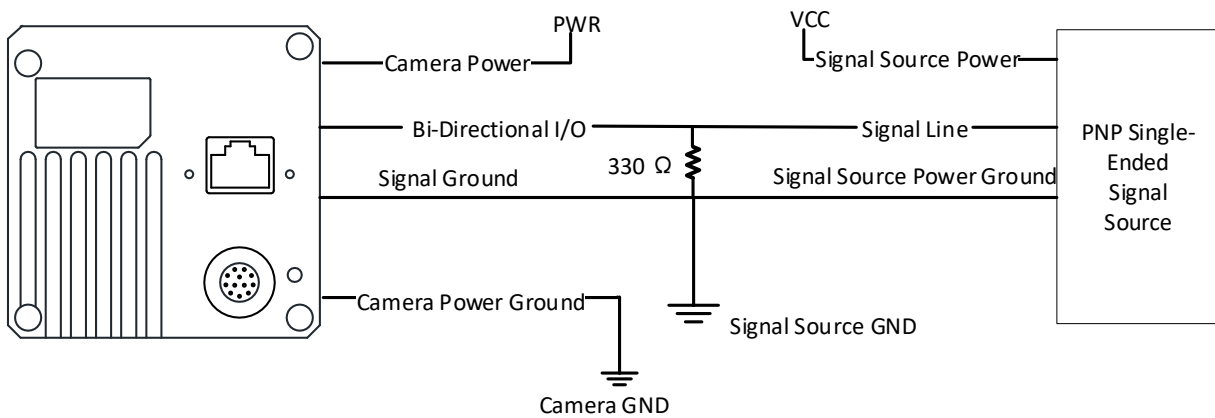

Figure 9-10 PNP Single-Ended Signal Source Connects Bi-Directional I/O

When the NPN single-ended signal source provides signal, and the camera's differential input is used as single-ended input. The VCC of NPN single-ended signal source is 5 V, 12 V or 24 V.

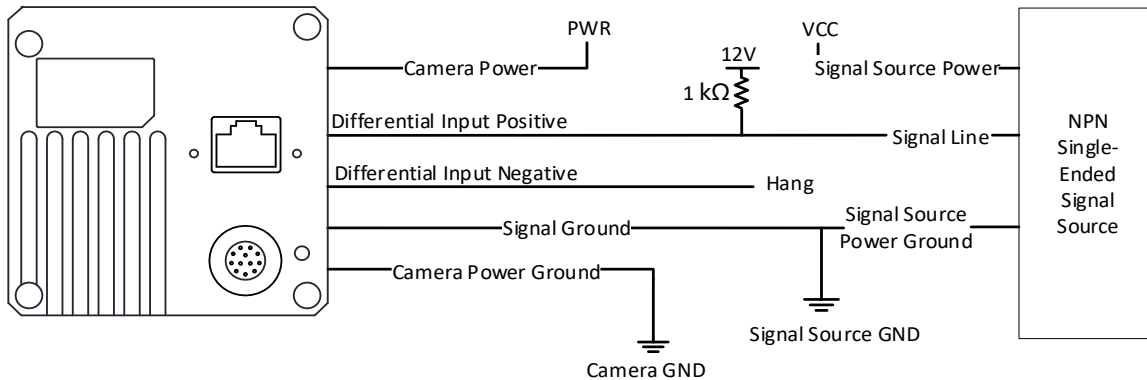

Figure 9-11 NPN Single-Ended Signal Source Connects Differential Input

When the NPN single-ended signal source provides bi-directional I/O to the camera, the wiring is shown below. The VCC of NPN single-ended signal source is 12 V or 24 V.

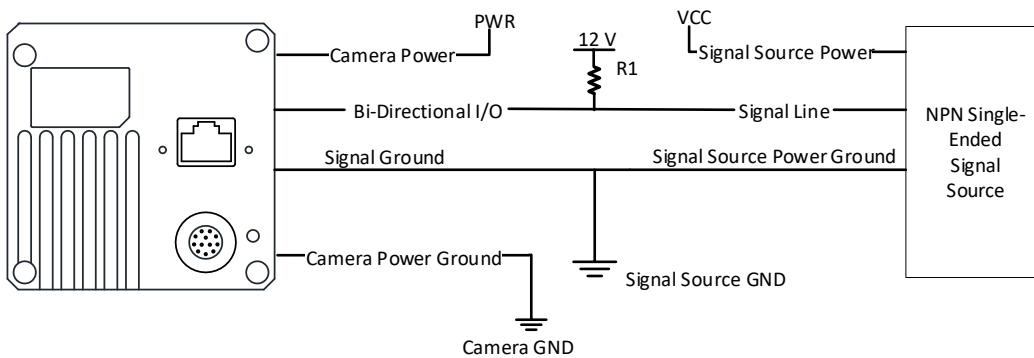

Figure 9-12 NPN Single-Ended Signal Source Connects Bi-Directional I/O

The R1 resistance values in the figure above is different by the voltages of NPN single-ended signal source, as shown blow.

Table 9-6 Relation between Voltage and Resistance

VCC	R1
12 V	1 KΩ
24 V	4.7 KΩ

9.3.2 Seond Type of Input Wiring

The differential signal source provides trigger signals.

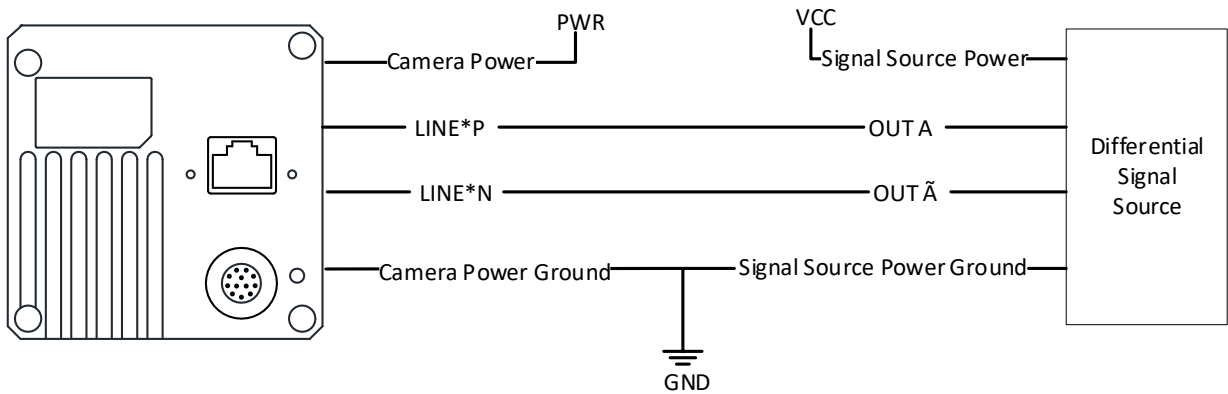

Figure 9-13 Differential Input Wiring

When the PNP single-ended signal source provides signal, there are two different wirings as shown below.

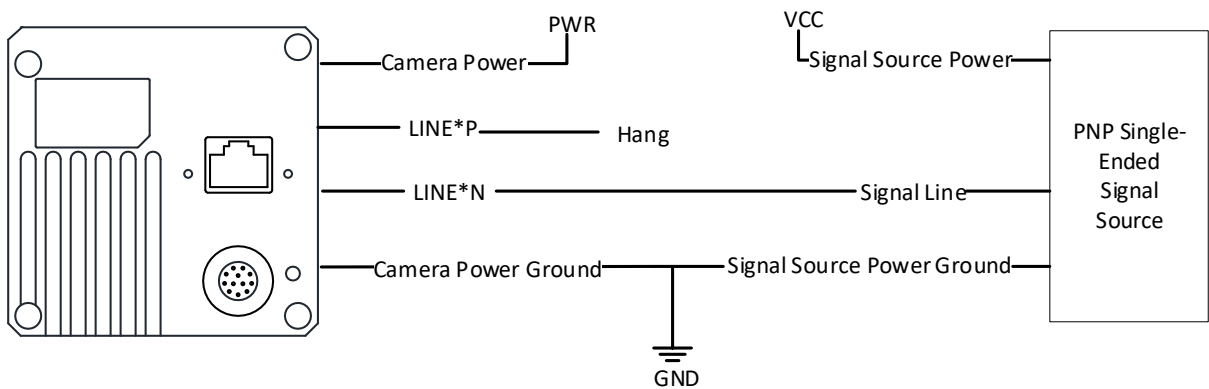

Figure 9-14 PNP Single-Ended Input Wiring without Pull-Down Resistor

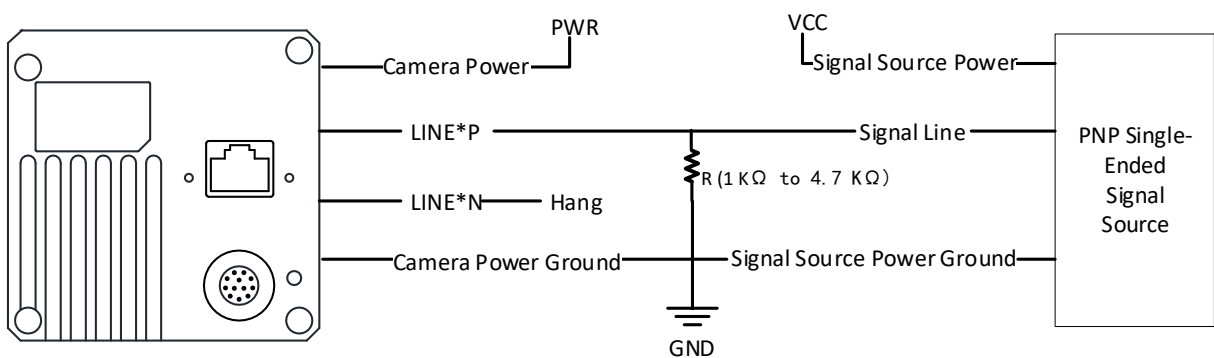

Figure 9-15 PNP Single-Ended Input Wiring with Pull-Down Resistor

When the NPN single-ended signal source provides signal, the wiring is shown below.

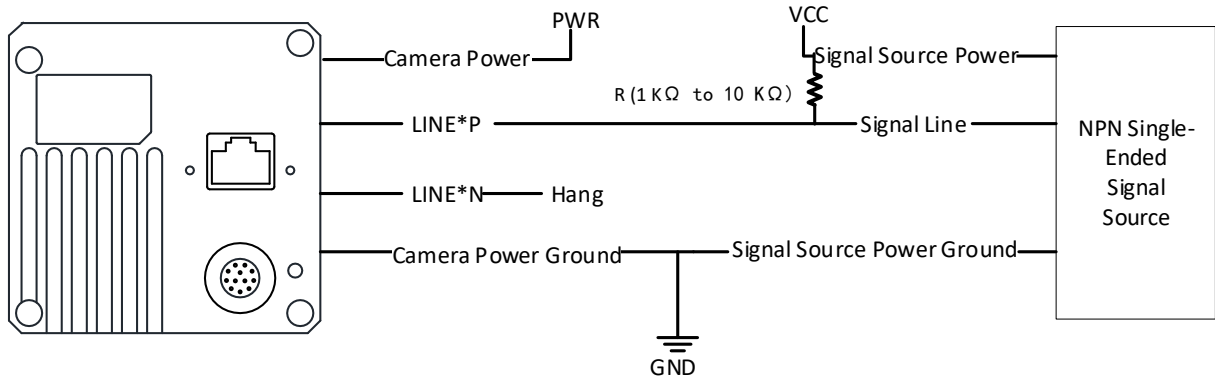

Figure 9-16 NPN Single-Ended Input Wiring

9.4 Output Wiring

The four bi-directional I/O of MV-CL022-91GM/GC, MV-CL042-91GM/GC, and 8K cameras can be set as output signals to trigger other devices.

NOTE

- The wiring may differ by I/O signals used as differential output or single-ended output.
- Here we take one type of GigE line scan cameras as an example to introduce the input wiring. Refer to the actual camera you got for specific appearance.

When I/O signals are used as differential output, the wiring is shown below.

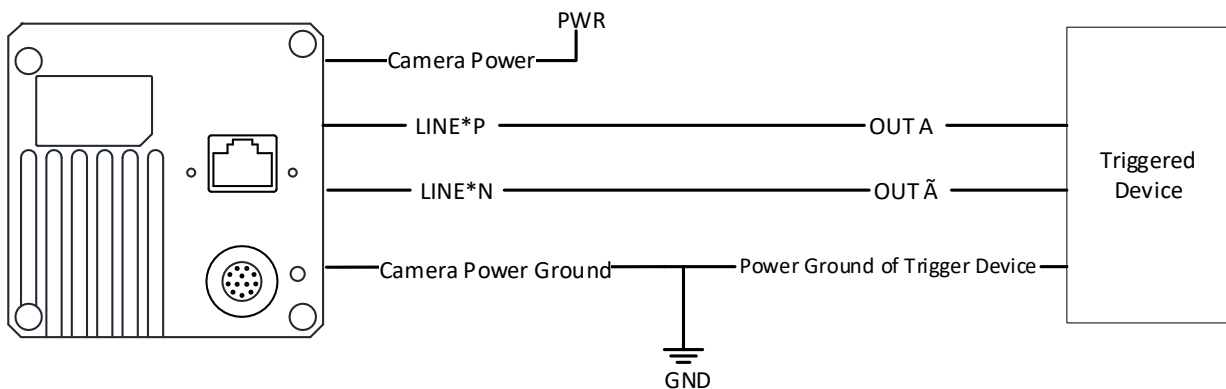

Figure 9-17 Differential Output Wiring

When I/O signals are used as single-ended output, the wirings are different according to the voltages of the triggered device.

- If the triggered device needs a LVTTTL of 3.3 V and below, the wiring is shown below.

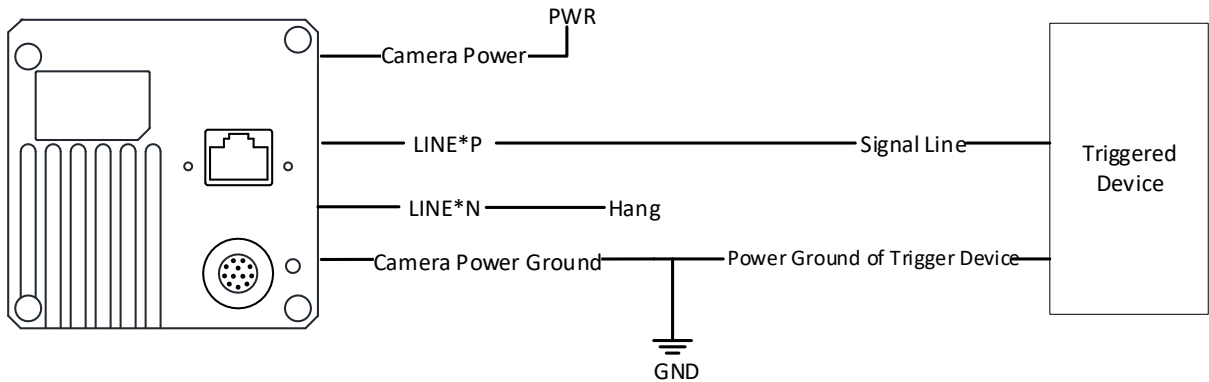

Figure 9-18 Single-Ended Output Wiring without Pull-Up Resistor

- If the triggered device needs a LVTTTL of 5 V and above, you should add a pull-up resistor between 1 K Ω and 10 K Ω .

NOTE

The voltage of VCC should be matched with the trigger voltage.

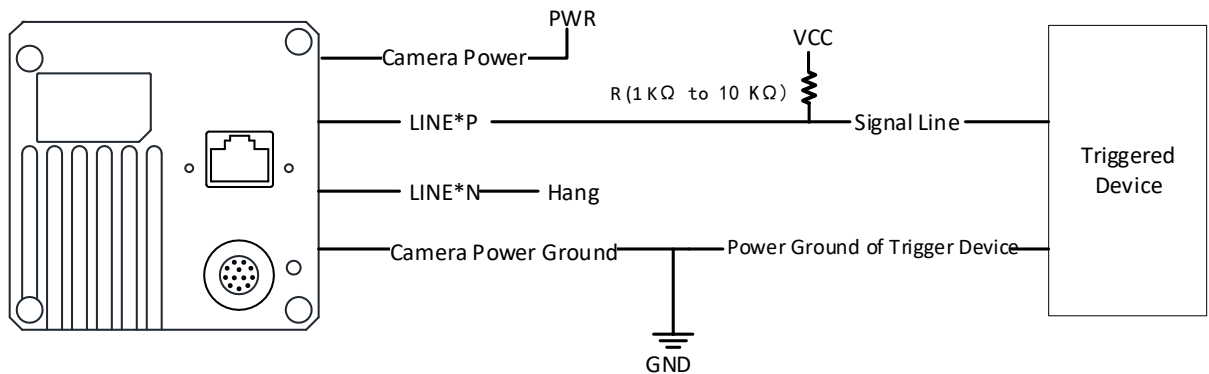

Figure 9-19 Single-Ended Output Wiring with Pull-Up Resistor

Chapter 10 Image Parameter

10.1 Image Resolution

Click **Image Format Control**, and check **Width Max** and **Height Max**. Width Max stands for the max. pixels per inch in width direction and Height Max stands for the max. pixels per inch in height direction.

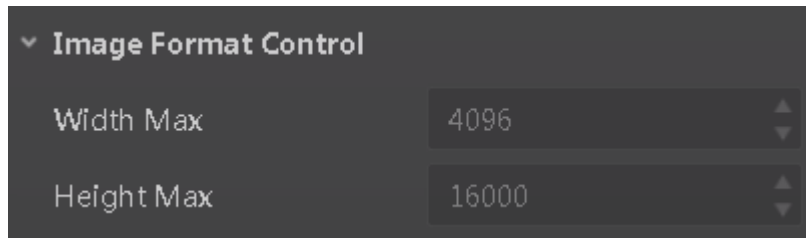

Figure 10-1 Image Resolution

NOTE

The camera displays images with max. resolution by default.

10.2 Set ROI

If you are only interested in a certain region of the image, you can set a Region of Interest (ROI) for the camera. Setting Region of Interest can reduce the bandwidth of the image being transmitted. Thus increasing the frame rate to some extent.

NOTE

- The camera currently supports 1 ROI only, that is, there is **Region 0** for **Region Selector** parameter only.
- Region of interest can be set only when you stop real-time acquisition.

Click **Image Format Control**, and set **Width**, **Height**, and **Offset X**.

- Width: it stands for horizontal resolution in ROI area.
- Height: it stands for vertical resolution in ROI area.
- Offset X: it refers to the horizontal coordinate of the upper left corner of the ROI.
- Offset Y: it refers to the vertical coordinate of the upper left corner of the ROI.

NOTE

For line scan camera, **Offset Y** is 0 by default and it cannot be edited.

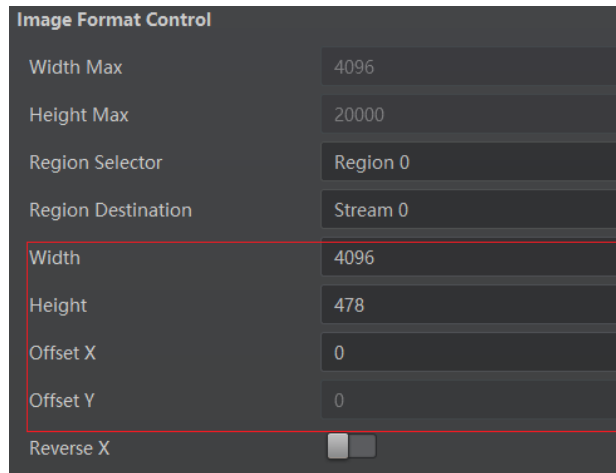

Figure 10-2 Set ROI

NOTE

- The Width value plus Offset X value should not be larger than Width Max parameter value.
- For different models of camera, the above-mentioned setting steps will be different, please refer to the actual one you got.

10.3 Set Image Reverse

NOTE

The image reverse function may differ by camera models.

The camera supports horizontal reverse image output. Click **Image Format Control**, and enable **Reverse X**.

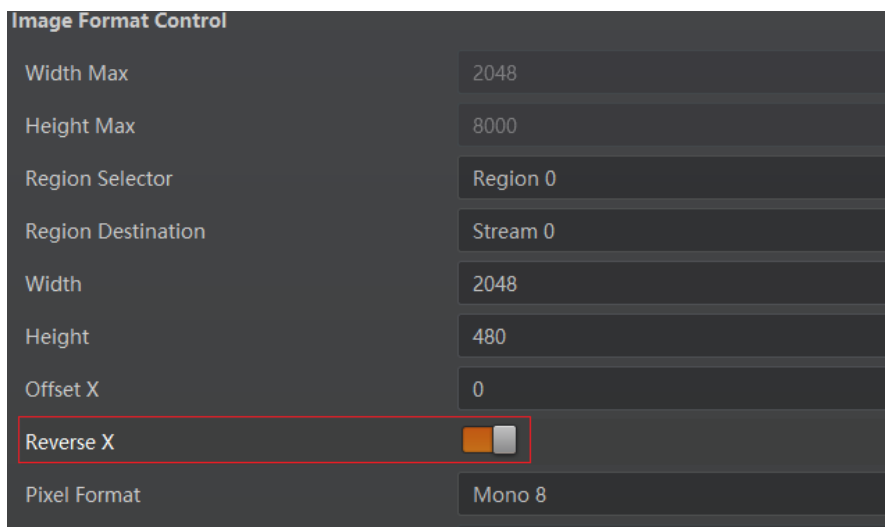

Figure 10-3 Set Image Reverse

10.4 Set Image Compression Mode

NOTE

The function of the image compression is related with camera models, firmware and pixel format, and the actual product you purchased should prevail.

Without affecting image quality, the High Bandwidth (HB) function allows the camera to speed up line and frame rates beyond the nominal link capacity.

Click **Image Format Control > Image Compression Mode**, and select **HB** as **Image Compression Mode**.



Figure 10-4 Set Image Compression Mode

You can view High Bandwidth related parameters like **HB Abnormal Monitor** and **HB Version** in device control attribute.

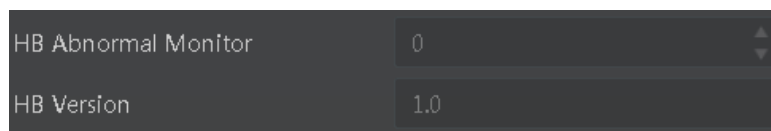

Figure 10-5 HB Abnormal Monitor and Version

- HB abnormal monitor is used to monitor image stream condition. If the size of compressed image is larger than that of raw image under HB function, this parameter will increase. When this parameter increases rapidly, it is recommended to disable HB function.
- HB version refers to the version of High Bandwidth function.

10.5 Set Pixel Format

NOTE

- The camera supports many pixel formats. For specific pixel formats that the camera supports, please refer to the Specifications of the camera.
- Pixel format can be set only when you stop real-time acquisition.

The default output data format of mono camera is Mono 8. The default output data format of color camera is Bayer 8, and it can be converted into RGB format via pixel interpolation algorithm. RGB format can be converted into YUV format via the algorithm, and YUV format can be converted into Mono 8 format. RGB format can be converted into BGR format via the order adjustment.

Bayer GR, Bayer GB, Bayer BG, Bayer RG and Bayer RBGG patterns are shown below.

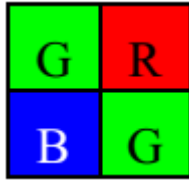

Figure 10-6 Bayer GR Pixel Pattern

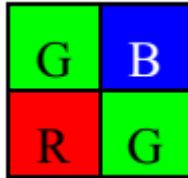

Figure 10-7 Bayer GB Pixel Pattern

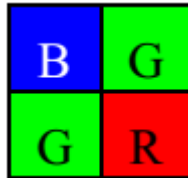

Figure 10-8 Bayer BG Pixel Pattern

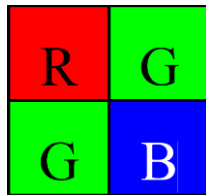

Figure 10-9 Bayer RG Pixel Pattern

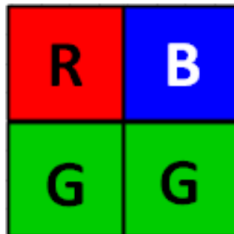

Figure 10-10 Bayer RBGG Pixel Pattern

For different pixel formats, they have varied data formats, and their relation is shown below. For max. line rate of different pixel formats, please refer to the actual condition.

Table 10-1 Data Format of Different Pixel Formats

Pixel Format	Pixel Size(Bits/Pixel)
Mono 8, Bayer 8, Bayer RBGG 8	8

Pixel Format	Pixel Size(Bits/Pixel)
Mono10 Packed, Mono 12 Packed, Bayer 10 Packed, Bayer 12 Packed	12
Mono 10/12, Bayer 10/12, YUV422Packed, YUV 422 (YUYV) Packed	16
RGB 8, BGR 8	24

Click **Image Format Control** > **Pixel Format**, and set **Pixel Format** according to actual demands.

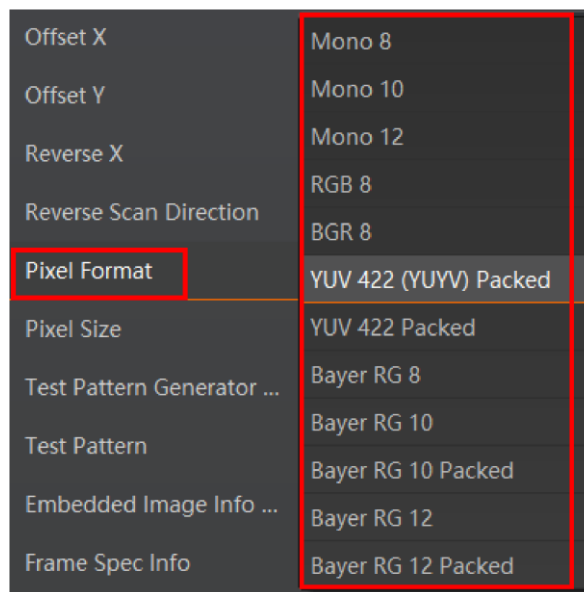

Figure 10-11 Set Pixel Format

10.6 Set Test Pattern

NOTE

The test pattern may differ by camera models.

The camera supports test pattern function. When there is exception in real-time image, you can check whether image of test mode have similar problem to determine the reason. This function is disabled by default, and at this point, the outputted image by the camera is real-time image. If this function is enabled, the outputted image by the camera is test image.

Click **Image Format Control** > **Test Pattern**, and set **Test Pattern** according to actual demands.

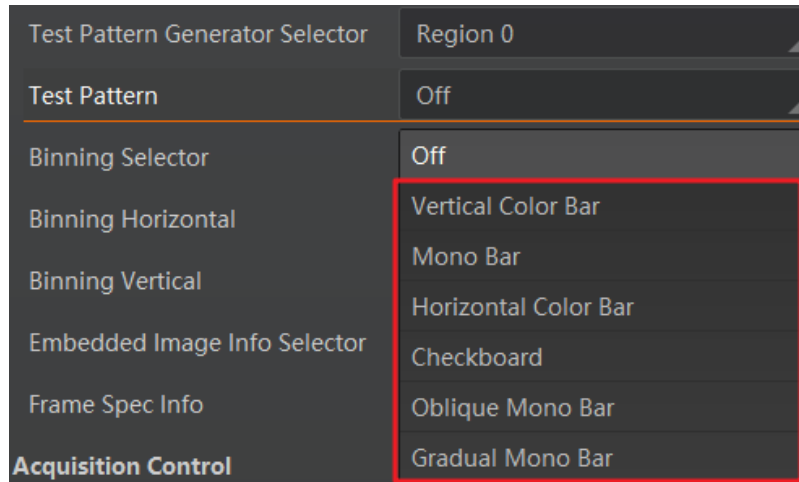

Figure 10-12 Test Pattern of Color Camera

The mono camera offers 4 test patterns, including Mono Bar, Checkboard, Oblique Mono Bar Gradual Mono Bar, and Test Image 1. For color camera, it also supports Vertical Color Bar and Horizontal Color Bar.



Figure 10-13 Mono Bar Test Pattern

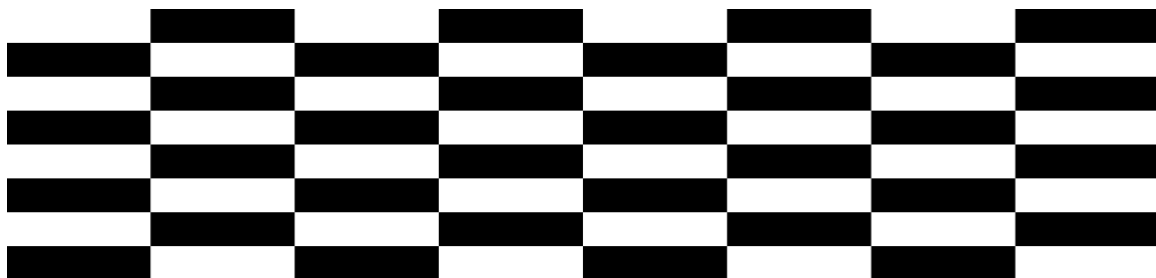

Figure 10-14 Checkboard Test Pattern

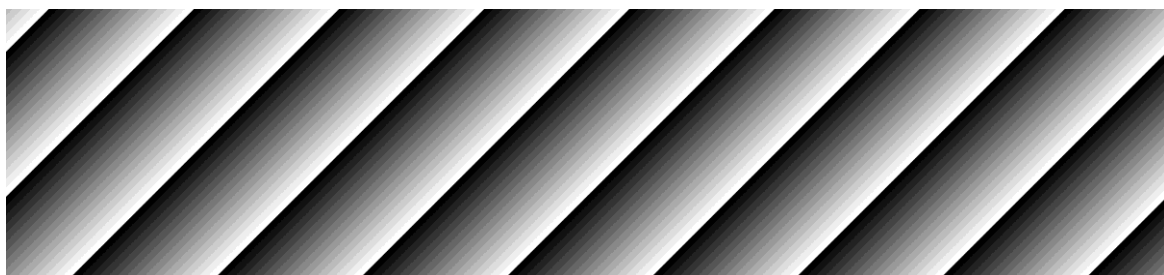

Figure 10-15 Oblique Mono Bar Test Pattern

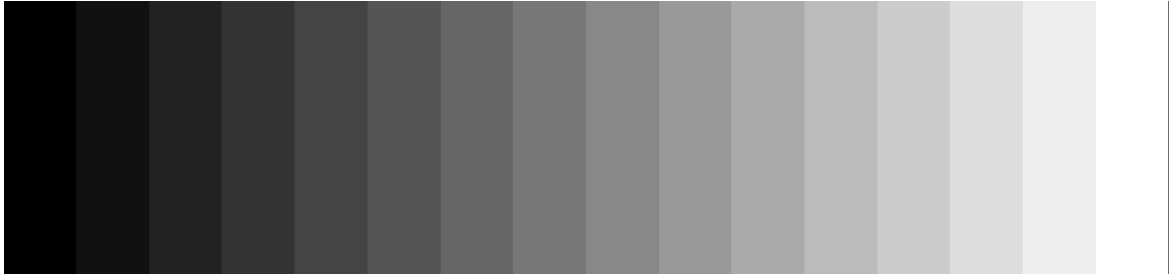

Figure 10-16 Gradual Mono Bar Test Pattern

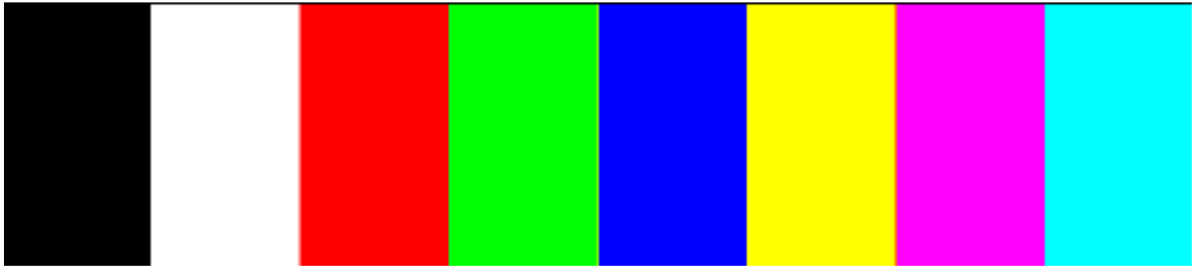

Figure 10-17 Vertical Color Bar Test Pattern



Figure 10-18 Horizontal Color Bar Test Pattern



Figure 10-19 Test Image 1 Test Pattern

 **NOTE**

The pattern of the test image 1 may differ by camera models.

10.7 Set Binning

 **NOTE**

The binning function may differ by camera models.

The purpose of setting binning is to enhance sensibility. With binning, multiple sensor pixels are combined as a single pixel to reduce resolution and improve image brightness.

Click **Image Format Control**, and set **Binning Horizontal** and **Binning Vertical**.

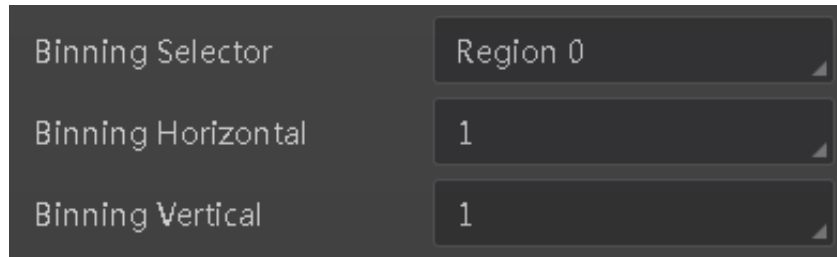

Figure 10-20 Set Binning

 **NOTE**

- **Binning Horizontal** refers to the image's width, and **Binning Vertical** refers to the image's height.
- If the camera's vertical resolution is 1, and there will be **Binning Horizontal** only.

10.8 Set Exposure Auto

The camera supports 3 types of exposure modes: **Off**, **Once** and **Continuous**. Click **Acquisition Control** > **Exposure Auto**, and select **Exposure Auto** according to actual demands. The exposure method and principle are shown below.

Table 10-2 Exposure Method and Principle

Exposure Method	Principle
Off	The camera exposures according to the value configured by user in Exposure Time .
Once	Adjust the exposure time automatically according to the image brightness. After adjusting, it will switch to Off Mode.
Continuous	Adjust the exposure time continuously according to the image brightness.

 **NOTE**

For 2K camera, when its trigger mode is line trigger, the camera's exposure time can be set manually, or be determined by external trigger width.

When the **Exposure Auto** is set as **Off**, you can enter **Exposure Time** manually. When the **Exposure Auto** is set as **Once** or **Continuous**, the exposure time should be within the range of **Auto Exposure Time Lower Limit** and **Auto Exposure Time Upper Limit**.

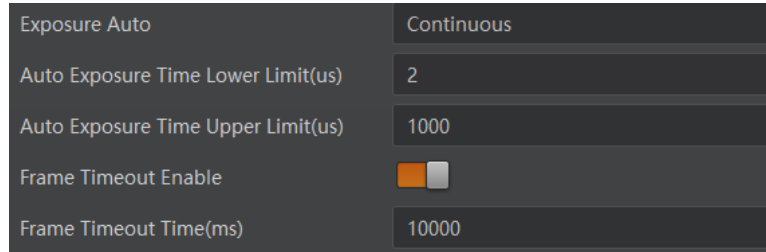

Figure 10-21 Set Exposure Time under Once or Continuous Mode

NOTE

If the camera is under **Continuous** exposure method, once external trigger mode is enabled, the camera will automatically switch to **Off** exposure mode.

10.9 Set HDR

NOTE

- The HDR function may differ by camera models. Refer to the specification of the camera for details.
- For some models of cameras, you need to enable TDI function first. Refer to section **TDI Function** for details.
- For some models of cameras, the gain you set in 2 sets of settings should be the same.

The camera supports HDR (High Dynamic Range) function that the camera acquires images based on 2 sets of settings, and each with its own exposure time and gain.

Click **Acquisition Control**, enable **HDR Enable**, select **0** as **HDR Selector**, and set **HDR Shutter**. And select **1** as **HDR Selector**, and set corresponding **HDR Shutter** to set the second HDR.

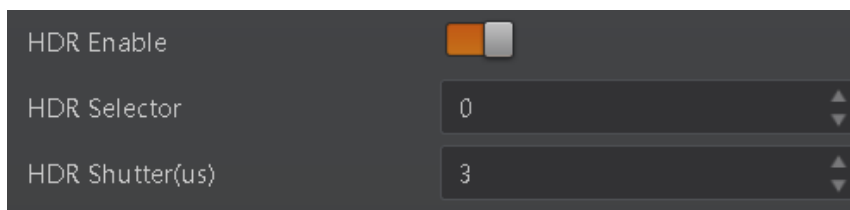

Figure 10-22 Set HDR

10.10 Set Gain

NOTE

The gain function may differ by camera models.

The camera has 2 types of gain, including the analog gain and digital gain. The analog gain is applied before the signal from the camera sensor is converted into digital values, while digital gain is applied after the conversion.

When increasing the analog gain, the image noise will increase too, which will influence image quality. If you want to increase image grayscale value, it is recommended to increase the camera's exposure time. If the exposure time reaches its upper limit, and at this point, you can increase analog gain.

10.10.1 Set Analog Gain

NOTE

For different models of the camera, the analog gain range and setting method may be different, please refer to the actual one you got.

● Gain

The camera supports 3 types of analog gain modes: **Off**, **Once** and **Continuous**. Click **Analog Control**, and select **Gain Auto** according to actual demands. The analog gain mode and principle are shown below.

Table 10-3 Analog Gain Mode and Principle

Gain Mode	Principle
Off	The camera adjusts gain according to the value configured by user in Gain .
Once	Adjust the gain automatically according to the image brightness. After adjusting, it will switch to Off Mode .
Continuous	Adjust the gain continuously according to the image brightness.

When the analog gain is set as **Once** or **Continuous**, the gain should be within the range of **Auto Gain Lower Limit** and **Auto Gain Upper Limit**.

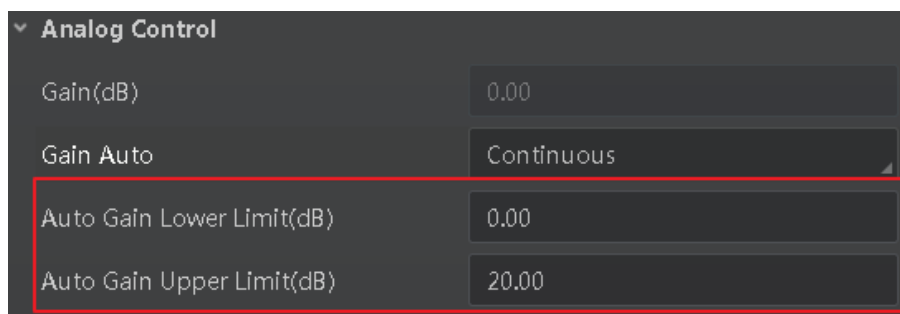

Figure 10-23 Set Gain under Once or Continuous Mode

If the current gain settings cannot meet demands and images are dark, you can enable **ADC Gain x 4 Enable** to allow you to set a larger gain, and it adds additional 12 dB to the value you set.

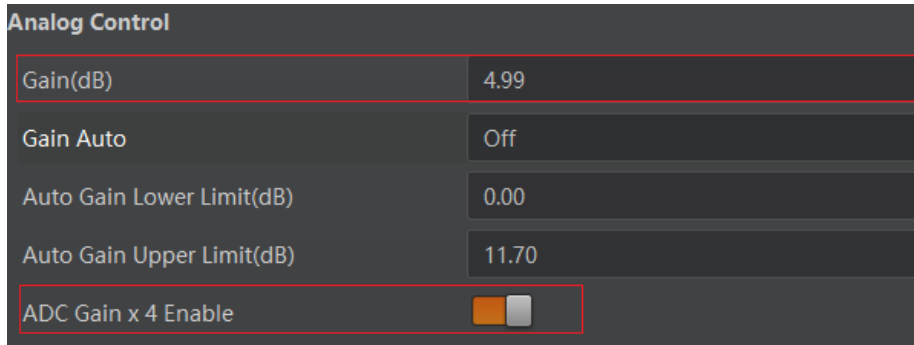

Figure 10-24 Set ADC Gain x 4 Enable

- **Preamp Gain**

Click **Analog Control > Preamp Gain**, and enter **Preamp Gain** according to actual demands.

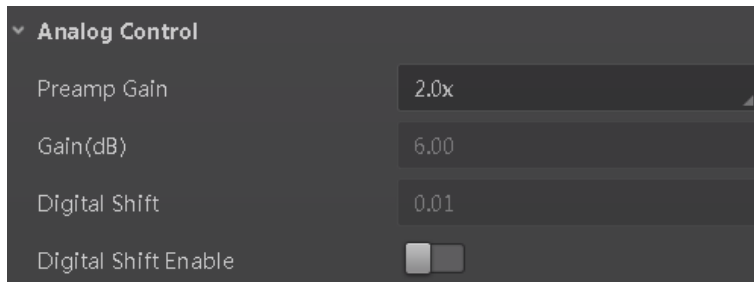

Figure 10-25 Set Preamp Gain

10.10.2 Set Digital Gain

Apart from analog gain, the camera also supports digital gain function.

Click **Analog Control**, enable **Digital Shift Enable**, and enter **Digital Shift**.



Figure 10-26 Set Digital Gain

 **NOTE**

When increasing the digital gain, the image noise will greatly increase too, which will severely influence image quality. It is recommended to use analog gain first, and then to adjust digital gain if the analog gain cannot meet demands.

10.11 Set Brightness

The camera brightness refers to the brightness when the camera adjusts image under **Once** or **Continuous** exposure mode, or **Once** or **Continuous** gain mode. You can set brightness as shown below.

 **NOTE**

You should enable **Once** or **Continuous** exposure mode, or **Once** or **Continuous** gain mode first before setting brightness.

Click **Analog Control** > **Brightness**, and set **Brightness** according to actual demand, and its range is from 0 to 255.

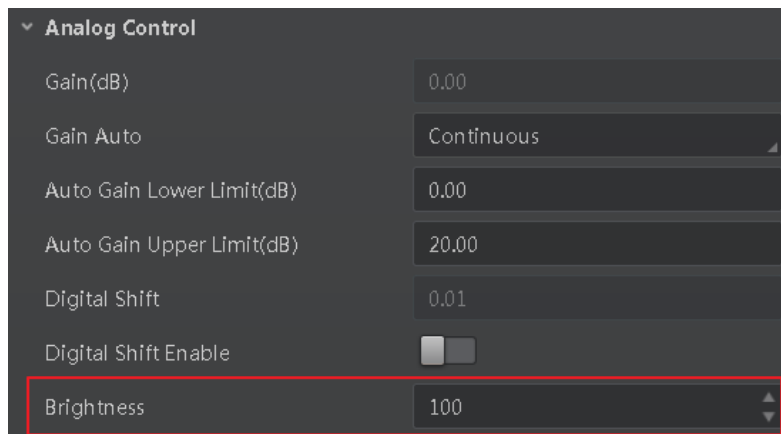

Figure 10-27 Set Brightness

 **NOTE**

After setting brightness, the camera will automatically adjust exposure time to let image brightness reach target one. Under **Once** or **Continuous** exposure mode, or **Once** or **Continuous** gain, the higher the brightness value, the brighter the image will be.

10.12 Set Black Level

The camera supports setting black level that refers to translate the level signal up and down. Increasing black level value makes image dark, reducing black level value makes image bright.

Click **Analog Control**, enable **Black Level Enable**, and enter **Black Level**.

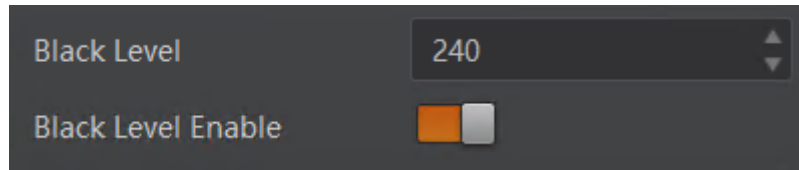

Figure 10-28 Set Black Level

10.13 Set White Balance

NOTE

White balance is only available for color cameras.

The white balance refers to the camera color adjustment depending on different light sources. Adjust the Gain Value of the image's R channel and B channel to keep white regions white under different color temperatures. Ideally, the proportion of R channel, G channel and B channel in the white region is 1:1:1.

Click **Analog Control** > **Balance White Auto**, and select **Balance White Auto** according to actual demands.

Table 10-4 White Balance Status Description

White Balance Mode	Description
Off	You need to set the R, G, B value manually, between 1 and 4095. 1024 means ratio is 1.0
Once	Automatic white balance once. Adjust the white balance for a certain amount of time then stop. It implements an algorithm that finds possible gray areas in the Bayer data.
Continuous	Continuous automatic white balance. It implements an algorithm that finds possible gray areas in the Bayer data.

It is recommended to correct white balance when there is great difference between the camera's color effect and actual effect. You can correct white balance as shown below.

Steps:

1. Put a white paper in the range of the camera's field of view, and make sure the paper covers the entire field of view.
2. Set exposure and gain. It is recommended to set image brightness value between 120 and 160.

NOTE

The default value of **Balance White Auto** is **Continuous**, and **AWB Color Temperature Mode** is **Narrow**. If the color effect is not good under this settings you can set **Wide** as **AWB Color Temperature Mode** to correct white balance.

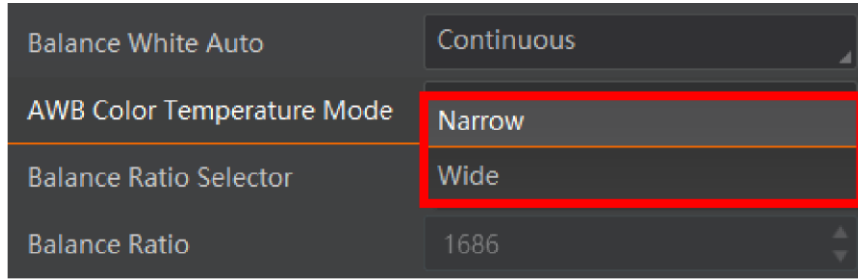

Figure 10-29 Set AWB Color Temperature Mode

If there is still great difference between correction effect and actual color, it is recommended to correct white balance according to following steps.

Steps:

1. Select **Off** as **Balance White Auto**. At this time, **Balance Ratio** is **1024**.
2. Find corresponding R/G/B channel in **Balance Ratio Selector**. Here we take **Green** as an example.
3. Find camera's R/G/B value.
4. Take **Green** as correction standard, and manually adjust other two channels (R channel and B channel) to let these three channels have same value.

 **NOTE**

- Here we take **Green** as an example. For specific **Balance Ratio Selector** value, please refer to the actual condition.
- In order to avoid repeated correction after rebooting the camera, it is recommended to save white balance parameter to **User Set** after white balance correction. You can refer to the Section **Save and Load User Set** for details.
- If the light source and color temperature in environment change, you need to correct white balance again.

10.14 Set Gamma Correction

 **NOTE**

Under Bayer pixel format, the MV-CL022-40GC camera does not support Gamma correction function.

The camera supports Gamma correction function. Generally, the output of the camera's sensor is linear with the photons that are illuminated on the photosensitive surface of the sensor. Gamma correction provides a non-linear mapping mechanism as shown below.

- Gamma value between 0.5 and 1: image brightness increases, dark area becomes brighter.
- Gamma value between 1 and 4: image brightness decreases, dark area becomes darker.

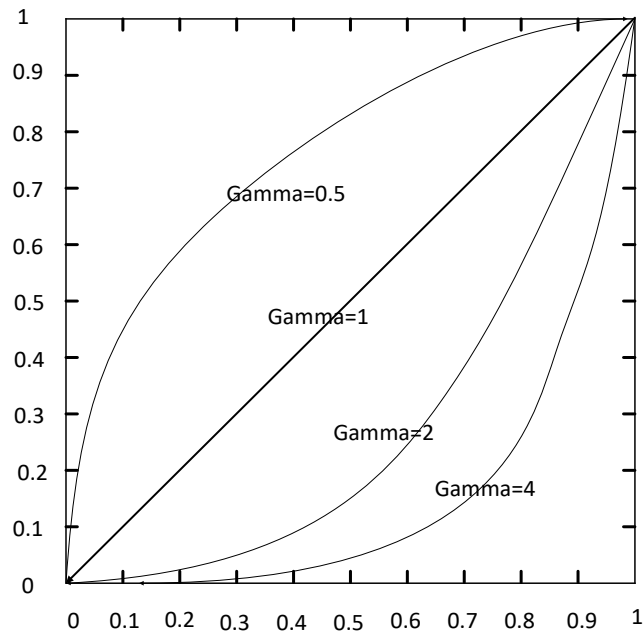

Figure 10-30 Gamma Curve

There are 2 types of Gamma correction, including **User** mode and **sRGB** mode. You can set User mode as shown below.

Steps:

1. Click **Analog Control > Gamma Selector**.
2. Select **User** as **Gamma Selector**.
3. Enable **Gamma Enable**.
4. Enter **Gamma** according to actual demands, and its range is from 0 to 4.

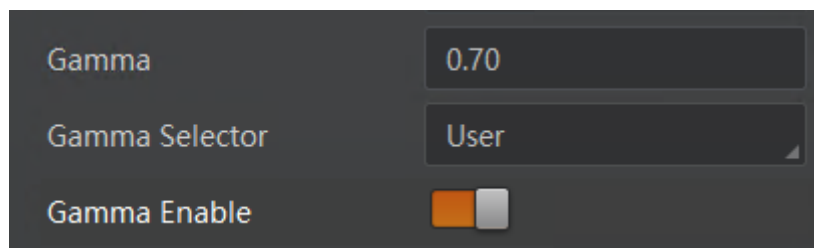

Figure 10-31 Set User Mode

You can set sRGB mode as shown below.

Steps:

1. Click **Analog Control > Gamma Selector**.
2. Select **sRGB** as **Gamma Selector**.
3. Enable **Gamma Enable**.

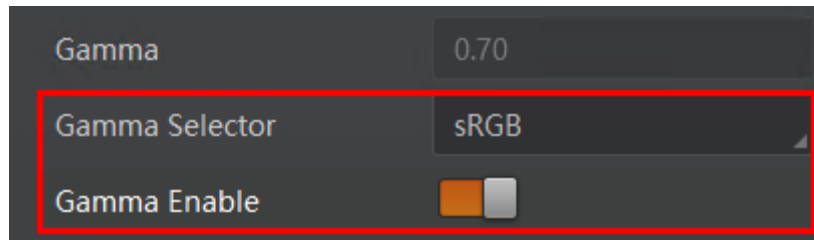

Figure 10-32 Set sRGB Mode

10.15 Set AOI

NOTE

The AOI function may differ by camera models.

The camera supports AOI function that can adjust the brightness and white balance of the entire image based on the area you selected.

Steps:

1. Click **Analog Control > Auto Function AOI Selector**, and select **AOI 1** or **AOI 2** as **Auto Function AOI Selector**.

NOTE

AOI 1 is used to adjust the image brightness, and **AOI 2** is used to adjust the white balance for color cameras.

2. Enter **Auto Function AOI Width**, **Auto Function AOI Height**, **Auto Function AOI Offset X**, and **Auto Function AOI Offset Y** according to actual demands.
3. Enable **Auto Function AOI Usage Intensity** if **AOI 1** is selected as **Auto Function AOI Selector**. Or enable **Auto Function AOI Usage White Balance** if **AOI 2** is selected as **Auto Function AOI Selector**.

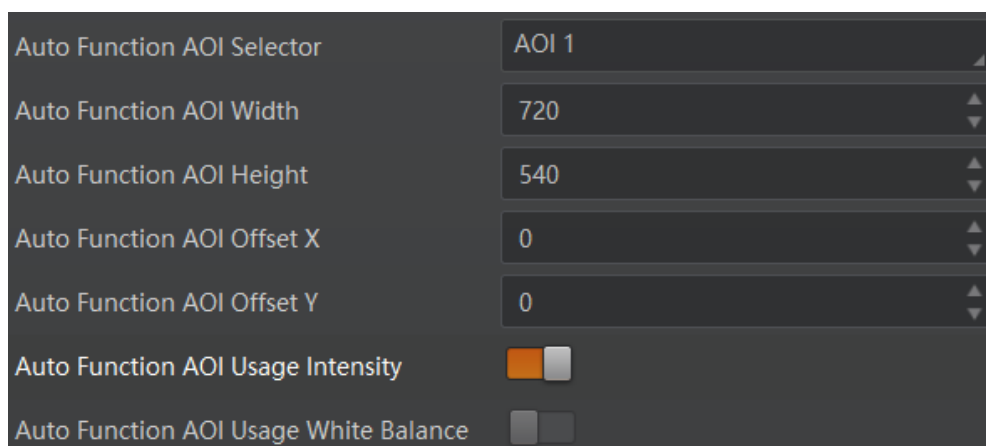

Figure 10-33 Set AOI

10.16 Set Color Transformation Control

NOTE

- Color transformation control is only available for color cameras.
- Under Bayer pixel format, the MV-CL022-40GC camera does not support color transformation control function.

After the process of the white balance, the color camera's overall images will look darker, and multiple colors may deviate from their standard values to some extent. At this time, you need to correct these colors by multiplying correction matrix to let them back to the standard value, so that the overall color of images is more vivid.

The color correction function is realized by multiplying each RGB component by a correction matrix. Currently, the supported color conversion module is RGB to RGB. Two methods are available to set color transformation control.

● Method 1

Click **Color Transformation Control**, enable **CCM Enable**, and set **Color Transformation Value** according to actual demand.

NOTE

The parameter of CCM enable may differ by camera models.

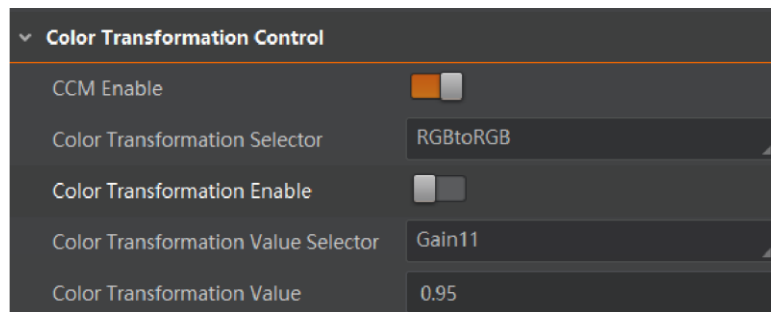

Figure 10-34 Method 1

● Method 2

Steps:

1. Click **Color Transformation Control**, and enable **CCM Enable**.
2. Enable **Color Transformation Enable**.
3. Set **Hue** and **Saturation** to adjust **Color Transformation Value**.

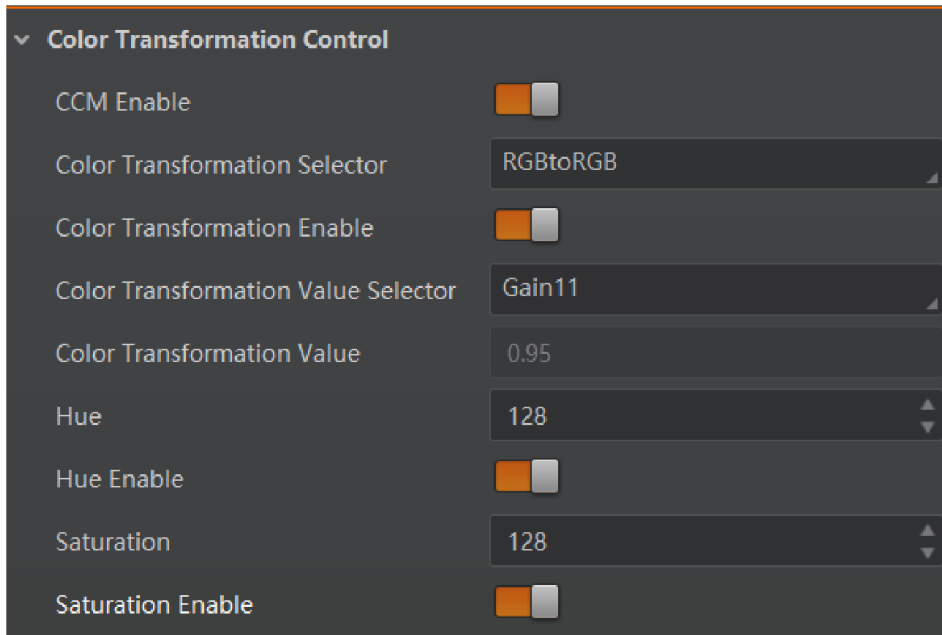

Figure 10-35 Method 2

10.17 Set Hue

NOTE

- Hue is only available for color cameras.
- Make sure the camera's pixel format is not in Mono format.
- Only the pixel format is YUV, RGB or BGR, the MV-CL022-40GC camera supports hue function.

Adjusting the hue shifts the colors of the image.

Steps:

1. Click **Color Transformation Control**, and enable **CCM Enable**.
2. Enable **Color Transformation Enable**.
3. Enable **Hue Enable**, and enter **Hue** according to actual demands.

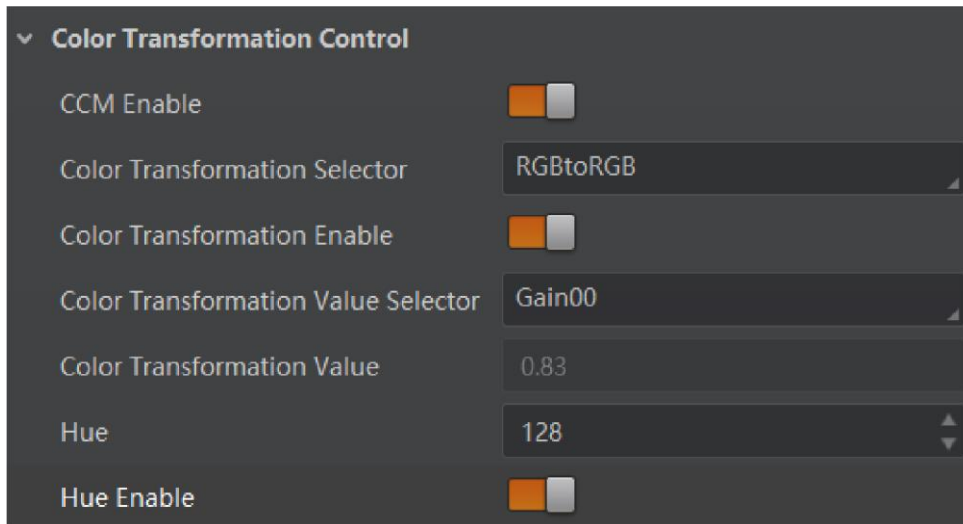

Figure 10-36 Set Hue

10.18 Set Saturation

NOTE

- Saturation is only available for color cameras.
- Make sure the camera's pixel format is not in Mono format.
- Only the pixel format is YUV, RGB or BGR, the MV-CL022-40GC camera supports saturation function.

Adjusting the saturation changes the colorfulness of the colors. A higher saturation makes colors easier to distinguish.

Steps:

1. Click **Color Transformation Control**, and enable **CCM Enable**.
2. Enable **Color Transformation Enable**.
3. Enable **Saturation Enable**, and enter **Saturation** according to actual demands.

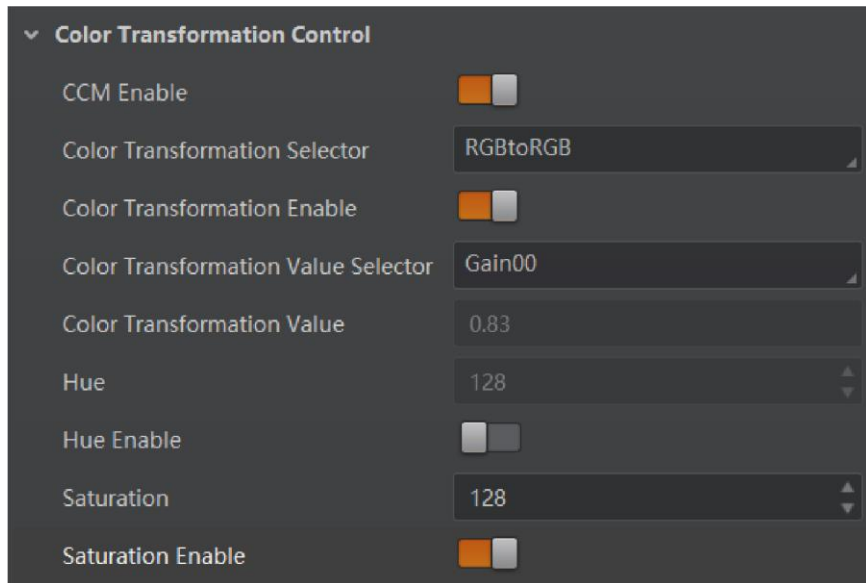

Figure 10-37 Set Saturation

10.19 Set Color Adjustment

NOTE

This function may differ by camera models.

Color adjustment function allows you to select different color areas in the image to set customized hue and saturation value.

Steps:

1. Click **Color Transformation Control**, and enable **Color Adjustment Enable**.

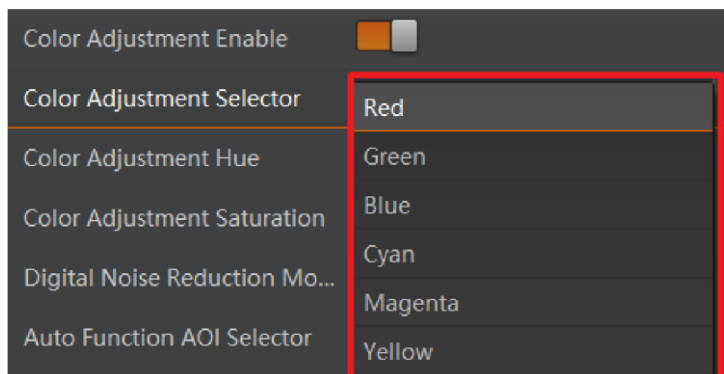

Figure 10-38 Select Color

2. Select **Color Adjustment Selector**, and set corresponding **Color Adjustment Hue** and **Color Adjustment Saturation** according to actual demands.

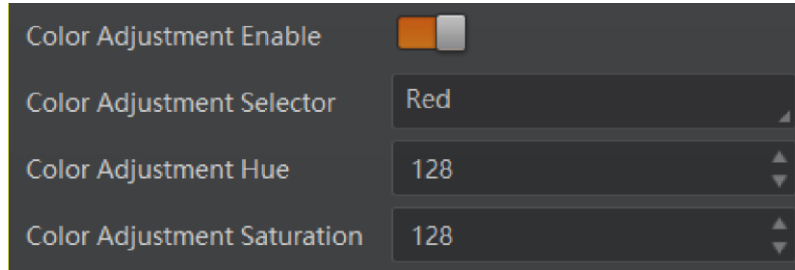

Figure 10-39 Set Color Adjustment

10.20 Set LUT

A Look-Up Table (LUT) is a customizable grayscale-mapping table. You can stretch, amplify the grayscale range that interests you. The mapping can be linear or customized curve.

NOTE

- Under Bayer pixel format, some camera models do not support LUT function.
- You cannot use Gamma correction function and LUT function at the same time.
- After using the TDI function, you need to set LUT again.

Steps:

1. Click **LUT Control**, and enable **LUT Enable**.
2. Enter **LUT Index** according to actual demands, and its range is from 0 to 1023.
3. Enter **LUT Value** according to actual demands, and its range is from 0 to 4095.
4. Click **Execute** in **LUT Save** to save it.

NOTE

The parameter of LUT Save may differ by camera models. If the camera has no LUT Save, the settings you configured will be saved in the camera in real time.

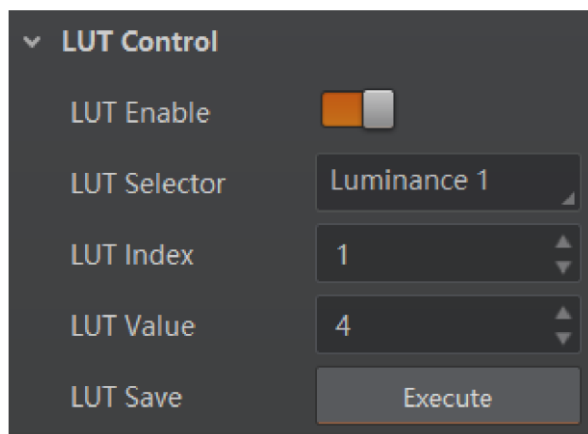

Figure 10-40 Set LUT

10.21 Set Flat Field Correction

NOTE

The flat field correction function and specific setting method may differ by camera models.

The flat field correction (FFC) includes PRNUC correction and FPNC correction, and they are used to improve the image uniformity that may be impacted by the sensor, light sources, external conditions, etc.

10.21.1 FPNC Correction

NOTE

The camera has completed FPNC correction by default and you do not need to set it again if the camera has no FPNC correction function.

Steps:

1. Click **Shading Correction**, and select **FPNC Correction** as **Shading Selector**.
2. Click **Execute** in **Activate Shading**, and enable **FPNC User Enable**.

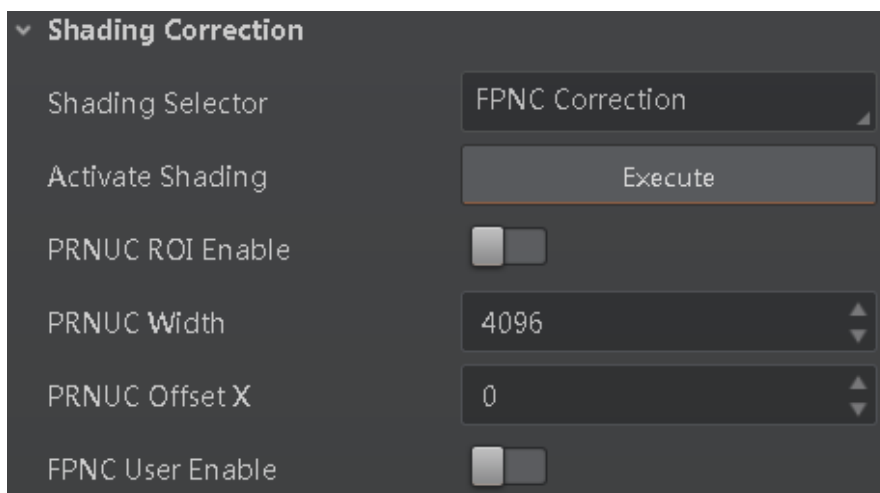

Figure 10-41 FPNC Correction

10.21.2 PRNUC Correction

NOTE

The camera currently supports PRNUC (Photo-response Non-Uniformity Correction) function that eliminates vertical line on the images. Two correction methods are available, including global correction and ROI correction. The effect of PRNUC correction is shown below.

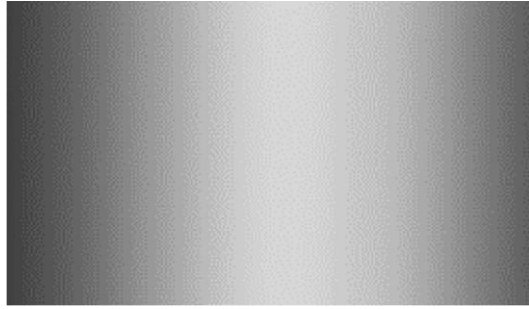

Figure 10-42 Before PRNUC Correction

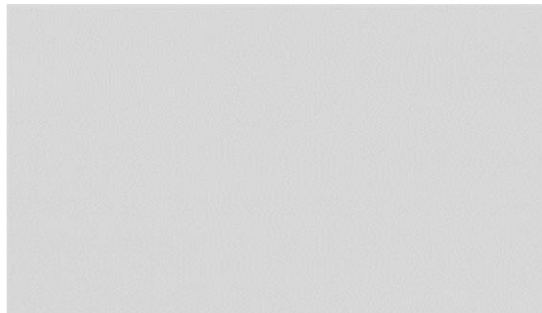

Figure 10-43 After PRNUC Correction

- **Global PRNUC Correction**

For MV-CL021-40GM camera, follow steps below to operate:

Steps:

1. Click **Shading Correction**, and click **Execute** in **Activate Shading**.
2. Enable **NUC Enable**, and **PRNUC Enable** will be enabled automatically.

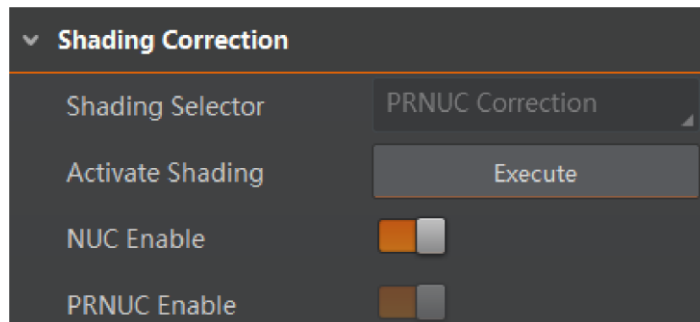

Figure 10-44 Set Shading Correction (I)

For MV-CL022-40GC camera, follow steps below to operate:

Steps:

1. Click **Shading Correction**, and set PRNUC target related parameters according to actual demands.

- Select **Off** as **PRNUC Target Enable** if you want to use the camera's auto correction standard. At this time, the camera compares and corrects the average R/G/B component value of each column with the average R/G/B component value of the entire image.
 - Select **On** as **PRNUC Target Enable** if you want to manually correct, and set **PRNUC Target R**, **PRNUC Target G**, and **PRNUC Target B** according to actual demands. At this time, the camera compares and corrects the average R/G/B component value of each column with the configured R/G/B value.
2. Click **Execute** in **Activate Shading**.
 3. Enable **NUC Enable**, and **PRNUC Enable** will be enabled automatically.

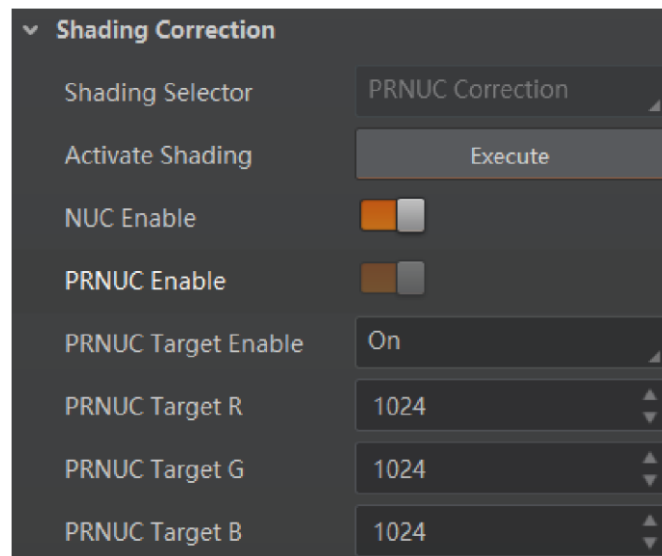

Figure 10-45 Set Shading Correction (II)

For other camera models, follow steps below to operate:

Steps:

1. Click **Shading Correction**, select **PRNUC User Selector**, and the camera starts to acquire images.
2. Set PRNUC target related parameters according to actual demands.
 - Disable **PRNUC Target Enable** if you want to use the camera's auto correction standard. At this time, the camera compares and corrects the average R/G/B component value of each column with the average R/G/B component value of the entire image.
 - Enable **PRNUC Target Enable** if you want to manually correct. For mono cameras, set **PRNUC Target**, and for color cameras, set **PRNUC Target R**, **PRNUC Target G**, and **PRNUC Target B** according to actual demands. At this time, the camera compares and corrects the average gray value or R/G/B component value of each column with the configured gray value or R/G/B value.
3. Click **Execute** in **Activate Shading**, and enable **PRNUC User Enable**.

4. (Optional) Enable **PRNUC Smooth Enable** to reduce the dust impact during calibration process.

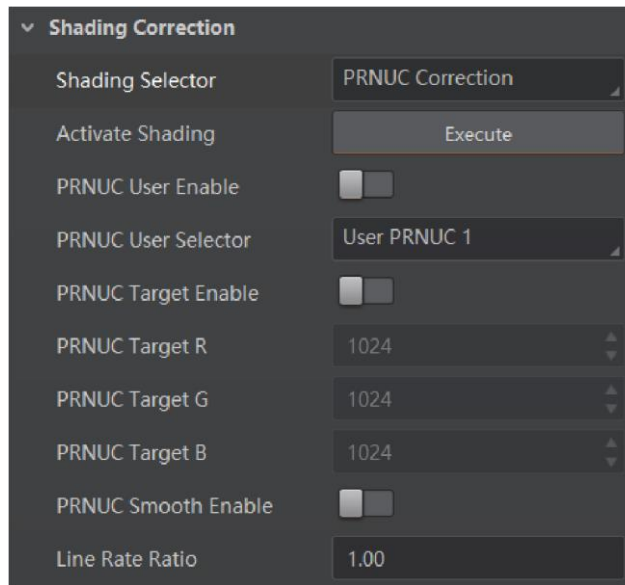

Figure 10-46 Set Shading Correction (III)

● ROI PRNUC Correction

If you want to execute PRNUC correction for specific areas, set **PRNUC Width** and **PRNUC Offset X** according to actual demands, and enable **PRNUC ROI Enable**.

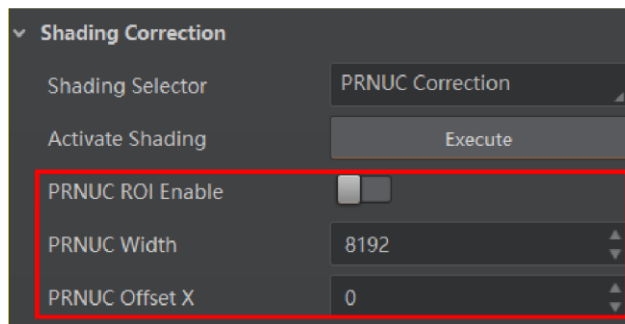

Figure 10-47 ROI PRNUC Correction

10.22 Set Space Correction

NOTE

The space correction function may differ by camera models.

The space correction (SC) includes line rate deviation correction and parallax deviation correction, and they are used to reduce image details deviation caused by line rate deviation or pixel deviation.

10.22.1 Set Line Rate Ratio

You can go to **Shading Correction**, and set **Line Rate Ratio** according to actual demands. Line rate ratio is used to adjust the ratio between the camera's line rate and that of the actual object to adjust the pixel deviation between upper line and lower line in images. Refer to the table below for effect contrast.

Table 10-5 Effect Contrast

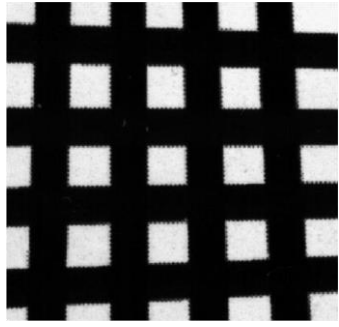
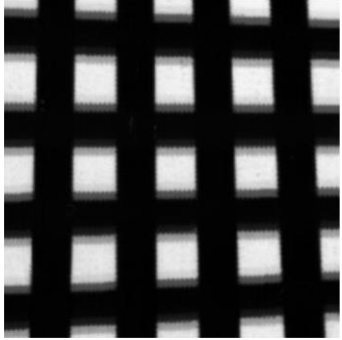
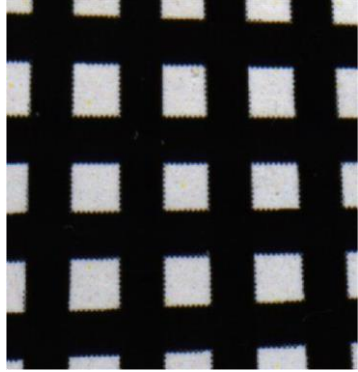
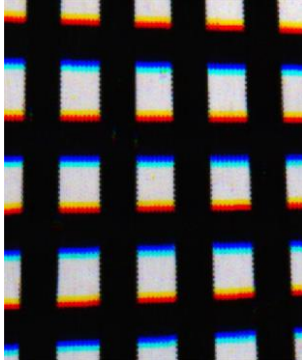
Camera Type	Normal Image	Abnormal Image
Mono Camera		
Color Camera		

- It is recommended to set line rate ratio larger than 1 when the camera's line rate is larger than that of the object.
- It is recommended to set line rate ratio smaller than 1 when the camera's line rate is smaller than that of the object.
- It is recommended to set line rate ratio as 1 when the camera's line rate is equal to that of the object.

 **NOTE**

The line rate ratio function is valid only when the camera is in TDI mode.

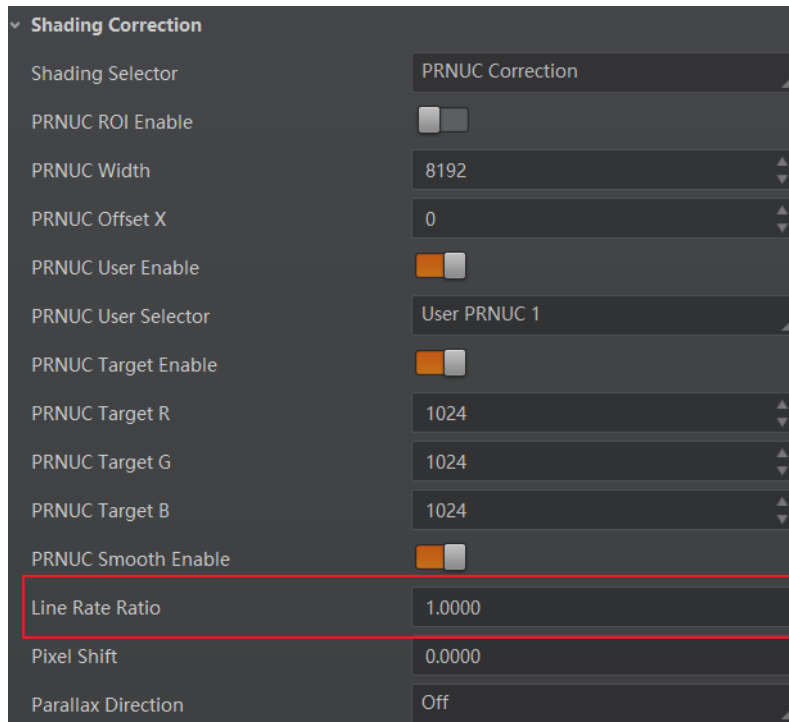

Figure 10-48 Set Line Rate Ratio

10.22.2 Set Pixel Shift and Parallax Direction

When pixel deviation occurs, images of mono cameras are vague and images of color cameras are dispersive. If you find the image's edge has pixel deviation via observation, follow steps below to alleviate it. Refer to the table below for effect contrast.

NOTE

If the overall image has the phenomenon below, it may be caused by lens optical structure deviation.

Table 10-6 Effect Contrast

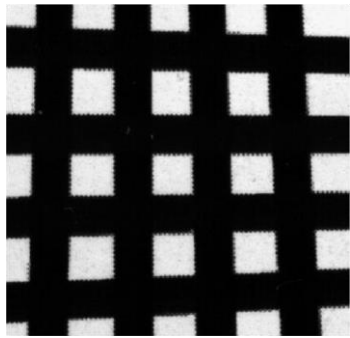
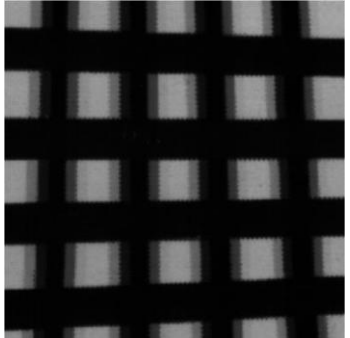
Camera Type	Normal Image	Abnormal Image
Mono Camera		

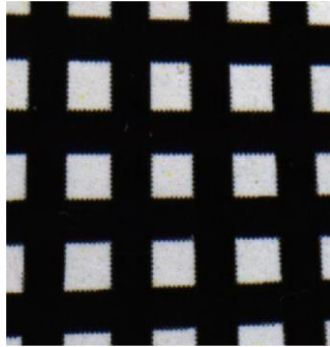
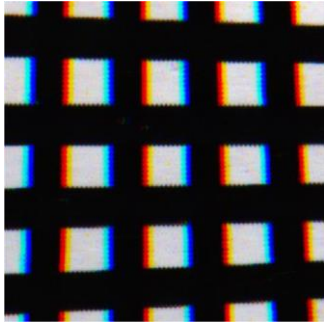
Camera Type	Normal Image	Abnormal Image
Color Camera		

Steps:

1. Set **Off** as **Parallax Direction** if the image's edge does not have pixel deviation.
2. Set **Parallax Direction** according to actual conditions if the image's edge has pixel deviation.
 - For the mono camera, if its upper sensor is closer to the measured objects, and select **Start Line** as **Parallax Direction**. Otherwise, select **End Line** instead.
 - For the color camera, if its sensor's B line is closer to the measured objects, and select **Blue** as **Parallax Direction**. If its sensor's R line is closer to the measured objects, and select **Red** instead.
3. Set **Pixel Shift** to have a best effect.

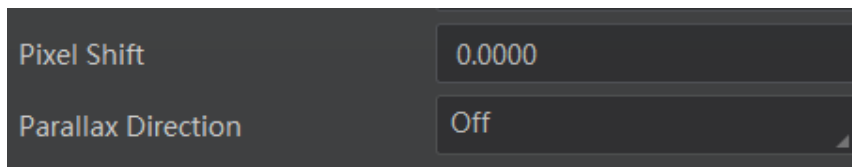

Figure 10-49 Set Parallax Direction and Pixel Shift

Chapter 11 Other Functions

11.1 Device Control



NOTE

The specific device control parameters may differ by camera models.

In the **Device Control** attribute, you can view device information, edit device name, reset device, etc. The specific parameters in **Device Control** attribute are shown below.

Table 11-1 Device Control Parameter Description

Parameter	Read/Write	Description
Device Type	Read only	It is the device type.
Device Scan Type	Read only	It is the scan type of the sensor.
Device Vendor Name	Read only	It is the name of device manufacturer.
Device Model Name	Read only	It is the device model.
Device Manufacture Info	Read only	It is the manufacturer information.
Device Version	Read only	It is the device version.
Device Firmware Version	Read only	It is the device firmware version.
Device Serial Number	Read only	It is the device serial number.
Device ID	Read only	It is the device ID.
Device User ID	Read and write	<p>Device name and it is empty by default. You can set according to your preference.</p> <ul style="list-style-type: none"> ● If User ID is empty, the client software displays the device model. ● If you set it, the client software displays the User ID you set.
Device Uptime (s)	Read only	It is the period of time when device is powered up.

Parameter	Read/Write	Description
Board Device Type	Read only	It is the device type.
Device Connection Selector	Read and write	It is the ID of GenICam XML.
Device Connection Speed (Mbps)	Read only	It is the device connection speed.
Device Link Selector	Read and write	It selects device link.
Device Link Speed (Mbps)	Read only	It is the link speed.
Device Link Connection Count	Read only	It is the link connection quantity.
Device Link Heartbeat Mode	Read and write	It enables heartbeat mode or not.
Device Stream Channel Count	Read only	It counts data packet quantity.
Device Stream Channel Selector	Read and write	It is the character set used in register.
Device Stream Channel Type	Read only	It is the stream channel type.
Device Stream Channel Link	Read only	It is the stream channel link quantity.
Device Stream Channel Endianness	Read only	It is the image data endianness.
Device Stream Channel Packet Size (B)	Read and write	It is the data packet size.
Device Event Channel Count	Read only	It is the channel quantity that the device supports.

Parameter	Read/Write	Description
Device Character Set	Read only	It is the character set used in register.
Device Reset	Read and write	Click Execute to reset the device.
Device Temperature Selector	Read and write	It selects device component to view temperature. Sensor supported only.
Device Temperature	Read only	It is the selected device component temperature.
Find Me	Read and write	Click Execute to let red indicator flash, and find device.
Device Max Throughput (Kbps)	Read only	It is the maximum flow of device operation.
Device PJ Number	Read only	It is the device serial number.
HB Abnormal Monitor	Read only	It is used to monitor image stream condition. If the size of compressed image is larger than that of raw image under HB function, this parameter will increase. When this parameter increases rapidly, it is recommended to disable HB function.
HB Version	Read only	It refers to the version of High Bandwidth function.

11.2 Embedded Information in Image

NOTE

The embedded information function and chunk data function may differ by camera models.

The camera supports adding and embedding the collection information to the image data. You can set in the client software and define which information to be embedded in the image data.

Embedded information includes following categories: **Timestamp, Gain, Exposure, Brightness Info, White Balance, Frame Counter, Ext Triggering Count, Line Input Output, Width, Height, Offset X, Offset Y, Pixel Format, and ROI Position**. Each category of embedded information has its unique data format.

Table 11-2 Embedded Information Data Format

No.	Information Type	Byte	Data Format Description
1	Timestamp	4 Bytes	4 bytes are used to transfer the timestamp information.
2	Gain	4 Bytes	4 bytes are used to transfer the gain information. Each low 8 bits of the 4 valid data are combined to transfer the gain information. Value Range: 0 to 1023. Note: High bits will be complemented with 0 automatically.
3	Exposure	4 Bytes	4 bytes are combined to show the exposure time, and the unit is μs .
4	Brightness Info	4 Bytes	4 bytes are used to transfer the brightness information. Value Range: 0 to 4095. Note: High bits will be complemented with 0 automatically.
5	White Balance	8 Bytes	R/G/B occupies 2 bytes each. Value Range: 0 to 4095.
6	Frame Counter	4 Bytes	Value Range: 0 to $2^{32}-1$.
7	Ext Trigger Count	4 Bytes	Value Range: 0 to $2^{32}-1$.
8	Line Input Output	4 Bytes	4 bytes are used to transfer the line input and output information.
9	Width	4 Bytes	Value Range: 0 to $2^{32}-1$.
10	Height	4 Bytes	Value Range: 0 to $2^{32}-1$.
11	Offset X	4 Bytes	Value Range: 0 to $2^{32}-1$.
12	Offset Y	4 Bytes	Value Range: 0 to $2^{32}-1$.
13	Pixel Format	4 Bytes	Value Range: 0 to $2^{32}-1$.
14	ROI Position	8 Bytes	The column coordinate occupies 2 bytes, and the row coordinate occupies 2 bytes. The column coordinate

No.	Information Type	Byte	Data Format Description
			information comes first. The length and width occupy 2 bytes respectively, and the length information comes first.

 **NOTE**

- The specific embedded information categories may differ by camera models.
- Color cameras have the white balance only. Embedded information types, including width, height, offset X, offset Y and pixel format, are for cameras that support the chunk data function only.
- The camera embeds category that you select into the image data. The ROI area do not influence collection information embedding. If the ROI area is small and there is not enough space in first line image, and then the collection information will be embedded into the second line image.
- The low 8-bit of each valid data storages image embedded information.

Click **Image Format Control > Embedded Image Info Selector**, select specific parameters as **Embedded Image Info Selector**, and enable **Frame Spec Info**.

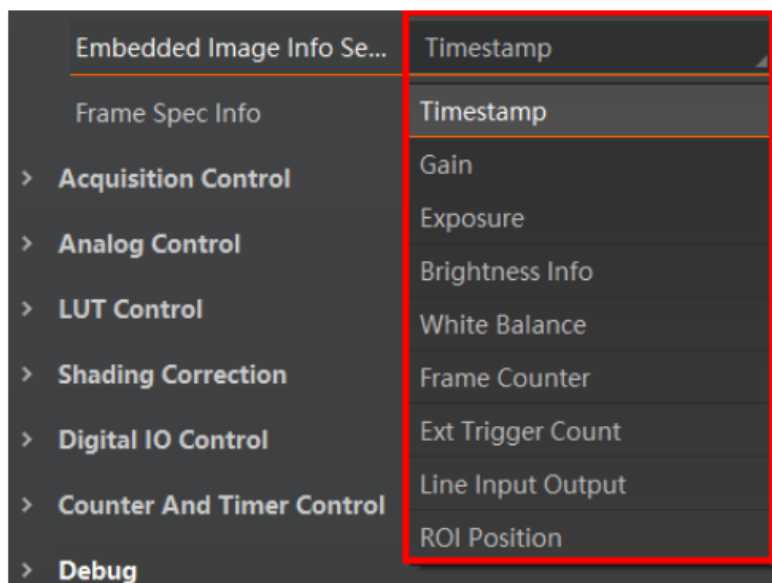

Figure 11-1 Set Embedded Information

You can also use the chunk data function to add the embedded information in images. The chunk data function allows you to generate supplementary image data and append that data to every image that you acquire.

 **NOTE**

- The chunk data function may differ by camera models.
- The chunk data function is not supported if the camera enables the image compression mode.
- The camera uses the chunk data function to realize embedded information in image in priority if you enable chunk data function and embedded information function both.

Steps:

1. Click **Chunk Data Control**.
2. Enable **Chunk Mode Active**.
3. Select specific parameters in **Chunk Selector** according to actual demands.
4. Enable **Chunk Enable**.

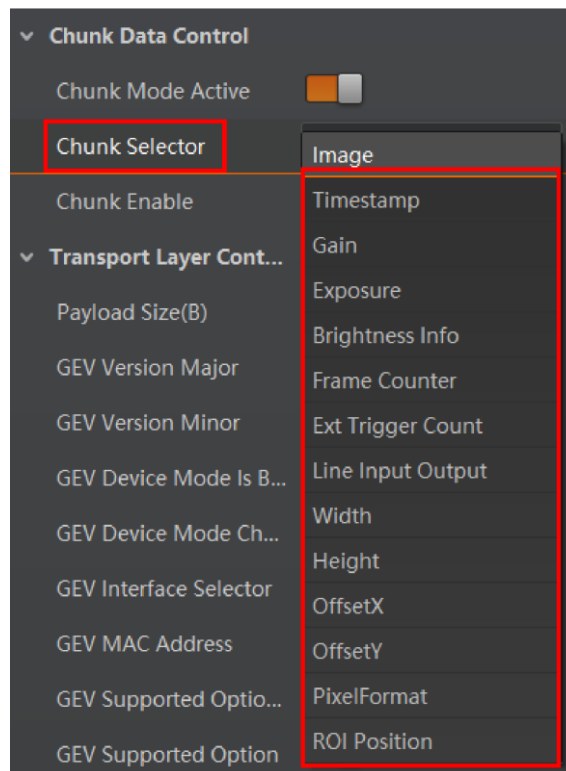

Figure 11-2 Set Chunk Data Control

11.3 TDI Function

 **NOTE**

- The TDI function may differ by camera models.
- When switching **TDI Mode**, the camera may have short period (3 s to 5 s) of image exception, which is a normal phenomenon.

TDI refers to Time Delay Integration, and it is a method of line scanning which provides dramatically increased responsivity compared to other video scanning methods. It permits much greater scanning speeds in low light, or allows reduced lighting levels (and costs) at conventional speeds.

In general, there are 3 TDI modes, including 1 line, 2-TDI and 4-TDI.

- 1 line refers to single line mode, and the camera selects 1 line data as output result.
- 2-TDI means that the camera overlaps 2 adjacent line data, and outputs 1 line data as final result.
- 4-TDI means that the camera overlaps 4-line data, and outputs 1 line data as final result.

Go to **Image Format Control > TDI Mode**, and set **TDI Mode** according to actual demands.



Figure 11-3 Set TDI Mode

11.4 Scan Direction

NOTE

- The scan direction function may differ by camera models.
- Make sure that the scan direction and the moving direction of objects are matched. Otherwise, acquired images may be abnormal.

The scan direction function is used to change the scan direction of the sensor used on measured objects. After selecting **TDI Mode**, you can go to **Image Format Control > Reverse Scan Direction** to enable **Reverse Scan Direction**.

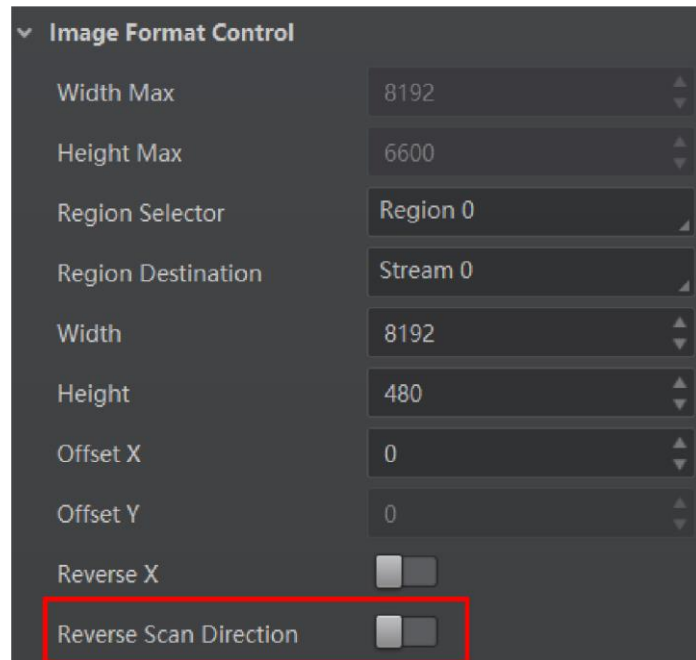

Figure 11-4 Set Scan Direction

11.5 File Access Control

The file access function allows you to export or import the camera's parameters, LUT and user PRNUC, and user FPNC in the mfa format. Currently, the camera supports User Set 1/2/3, LUT Luminance 1/2/3, User PRNUC 1/2/3, and User FPNC.

NOTE

- The file access control function and specific device features that can be imported and exported may differ by camera models.
- Make sure that you have stopped acquisition before using this function.
- Make sure that the firmware is same when exporting or importing files between two cameras.

Steps:

1. Select the camera in the device list.
2. Click  to open the **File Access** interface.

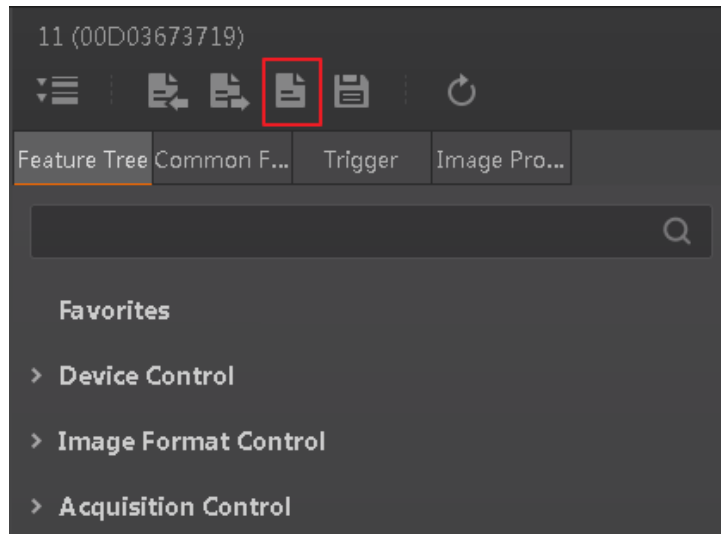

Figure 11-5 File Access

3. Select **Device Feature** according to actual demands.

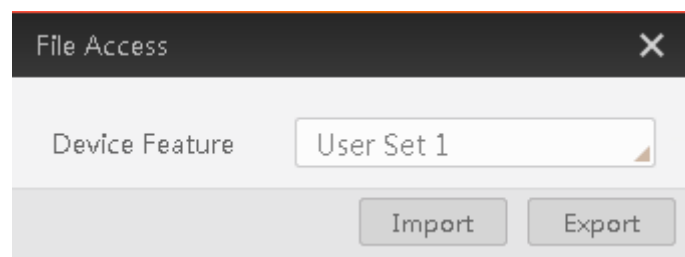

Figure 11-6 Select Device Feature

4. Click **Import** or **Export** to import or export files.

 **NOTE**

The camera has different process approaches when you select different device features.

- If User Set 1/2/3 is selected as device feature, you need to load the corresponding user set you selected to take effect.
- If LUT Luminance 1/2/3 is selected as device feature, and they will take effect only when you select the same parameters in LUT Selector.
- If User PRNUC 1/2/3 is selected as device feature, and they will take effect only when you select the same parameters in PRNUC User Selector.
- If User FPNC is selected as device feature, and it will take effect immediately after enabling FPNC User Enable.

11.6 Event Control

NOTE

The event control function may differ by camera models.

The event control function allows you to enable event notification and view camera events.

When **Event Notification** is set as **Notification On**, the camera can generate an event and transmit a related event message to the computer whenever a specific situation occurs.

Steps:

1. Click **Event Control**, select specific event in **Event Selector**.

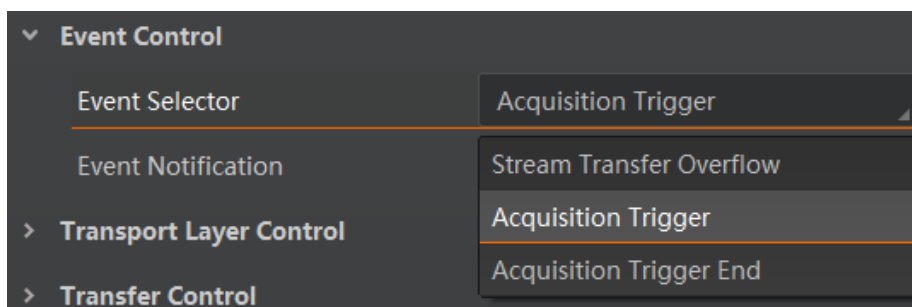

Figure 11-7 Set Event Control

2. Select **Notification On** as **Event Notification**.
3. Right click the connected device in device list, and click **Event Monitor**.
4. Check **Messaging Channel Event**. When specific event occurs, the event monitor window displays time and event content.

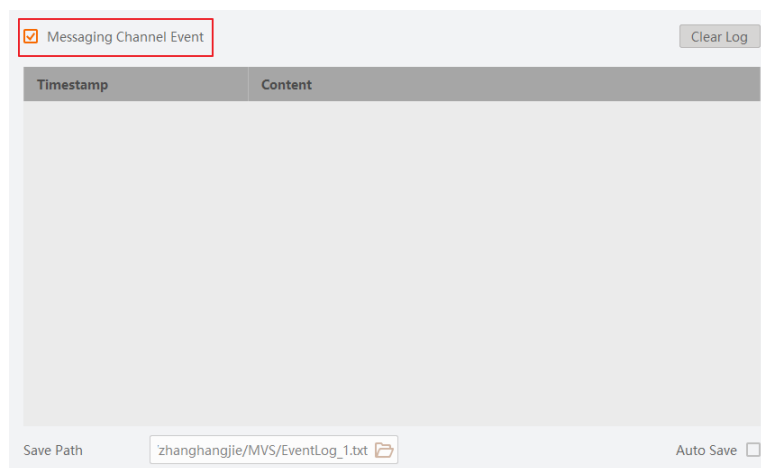

Figure 11-8 Event Monitor Window

11.7 Transport Layer Control



NOTE

The specific transport layer control parameters may differ by camera models.

You can go to **Transport Layer Control** to view the camera's load size, GEV version, etc.

Table 11-3 Transport Layer Control Description

Parameter	Read/Write	Description
Payload Size (B)	Read only	It is the camera's load size.
GEV Version Major	Read only	It is the major version in GEV version.
GEV Version Minor	Read only	It is the minor version in GEV version.
GEV Device Mode Is Big Endian	Read only	It is the endianness in device's register.
GEV Device Mode Character Set	Read only	It is the character set in device's register.
GEV Interface Selector	Read only	It sets which physical network interface to be controlled.
GEV MAC Address	Read only	It is the MAC address of the network interface.
GEV Supported Option Selector	Read and write	It selects the GEV option to interrogate for existing support.
GEV Supported Option	Read only	It indicates whether the selected GEV option is supported or not.
GEV Current IP Configuration LLA	Read only	It indicates whether the Link Local Address IP configuration scheme is activated on the given network interface.
GEV Current IP Configuration DHCP	Read and write	It indicates whether the DHCP IP configuration scheme is activated on the given network interface.
GEV Current IP Configuration Persistent IP	Read and write	It indicates whether persistent IP configuration scheme is activated on the given network interface.

Parameter	Read/Write	Description
DEV PAUSE Frame Reception	Read and write	It controls whether incoming pause frames are handled on the given logical link.
GEV Current IP Address	Read only	It is the current IP address for the given network interface.
GEV Current Subnet Mask	Read only	It is the current subnet mask of the given interface.
GEV Current Default Gateway	Read only	It is the default gateway IP address to be used on the given network interface.
GEV First URL	Read only	It is the first choice of URL for the XML device description file.
GEV Second URL	Read only	It is the second choice of URL to the XML device description file.
GEV Number Of Interfaces	Read only	It indicates the number of physical network interfaces supported by this device.
GEV Persistent IP Address	Read and write	It indicates the persistent IP address for this network interface. It is only used when the device boots with the persistent IP configuration scheme.
GEV Persistent Subnet Mask	Read and write	It indicates the persistent subnet mask associated with the persistent IP address on this network interface. It is only used when the device boots with the persistent IP configuration scheme.
GEV Persistent Default Gateway	Read and write	It indicates the persistent default gateway for this network interface. It is only used when the device boots with the persistent IP configuration scheme.
GEV Link Speed	Read only	It indicates the speed of transmission negotiated by the given network interface in Mbps.
GEV Message Channel Count	Read only	It indicates the number of message channels supported by this device.
GEV Stream Channel Count	Read only	It indicates the number of stream channels supported by this device.

Parameter	Read/Write	Description
GEV Heartbeat Timeout (ms)	Read and write	It indicates the current heartbeat timeout in milliseconds.
GEV Heartbeat Disable	Read and write	It disables the GEV Heartbeat.
GEV Timestamp Tick Frequency (Hz)	Read only	It indicates the number of timestamp ticks in 1 second (frequency in Hz).
Timestamp Control Latch	Read and write	It latches the current timestamp value of the device.
Timestamp Control Reset	Read and write	It resets the timestamp value for the device.
Timestamp Control Latch Reset	Read and write	It resets the timestamp control latch.
Timestamp Value	Read only	It is a read only element. It indicates the latched value of the timestamp.
GEV CCP	Read and write	It controls the device access privilege of an application.
GEV MCP Host Port	Read and write	It controls the port to which the device must send messages. Setting this value to 0 closes the message channel.
GEV MCDA	Read and write	It controls the destination IP address for the message channel.
GEV MCTT (ms)	Read and write	It provides the transmission timeout value in milliseconds.
GEV MCRC	Read and write	It controls the number of retransmissions allowed when a message channel message times out.
GEV MCSP	Read only	It indicates the source port for the message channel.

Parameter	Read/Write	Description
GEV Stream Channel Selector	Read only	It selects the stream channel to control.
GEV SCP Interface Index	Read only	It is the Index of network interface to be used.
GEV SCP Host Port	Read and write	It is the host port of the channel
GEV SCP Direction	Read only	It transmits or receives the channel.
GEV SCPS Fire Test Packet	Read only	It sends a test packet.
GEV SCPS Do Not Fragment	Read and write	The state of this feature is copied into the “do not fragment” bit of the IP header of each stream packet.
GEV SCPS Big Endian	Read only	It is the Endianness of multi-byte pixel data for this stream.
GEV SCPS Packet Size (B)	Read and write	It specifies the stream packet size (in bytes) to send on this channel.
GEV SCPD	Read and write	It indicates the delay (in timestamp counter units) to insert between each packet for this stream channel.
GEV SCDA	Read and write	It indicates the destination IP address for this stream channel.
GEV SCSP	Read only	It indicates the source UDP port address for this stream channel.
Gev IEEE 1588	Read and write	It enables the IEEE 1588 Precision Time Protocol to control the timestamp register.
Gev GVSP Extended ID Mode	Read and write	It enables the extended ID mode.

11.8 Transfer Control

You can view the camera's transfer status in transfer control attribute.

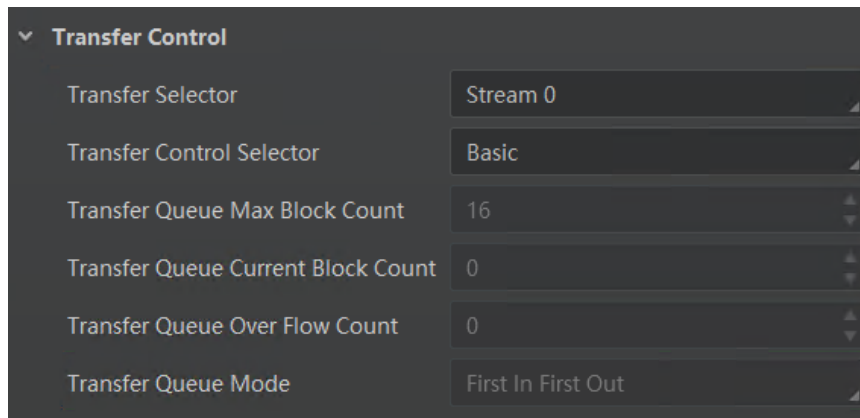

Figure 11-9 Transfer Control Attribute

Table 11-4 Parameter Description

Parameter	Description
Transfer Selector	It selects stream channel.
Transfer Control Selector	It sets control mode, and the camera currently supports Basic only.
Transfer Queue Max Block Count	It refers to the max. image quantity that the camera memory can save.
Transfer Queue Current Block Count	It refers to the current saved image quantity in the camera memory.
Transfer Queue Over Flow Count	It refers to the number of covered images in the camera memory.
Transfer Queue Mode	It refers to the camera memory queue mode.

11.9 Save and Load User Set

The camera supports 4 sets of parameters, including 1 default set and 3 user sets. The relation among 4 sets of parameters is shown below.

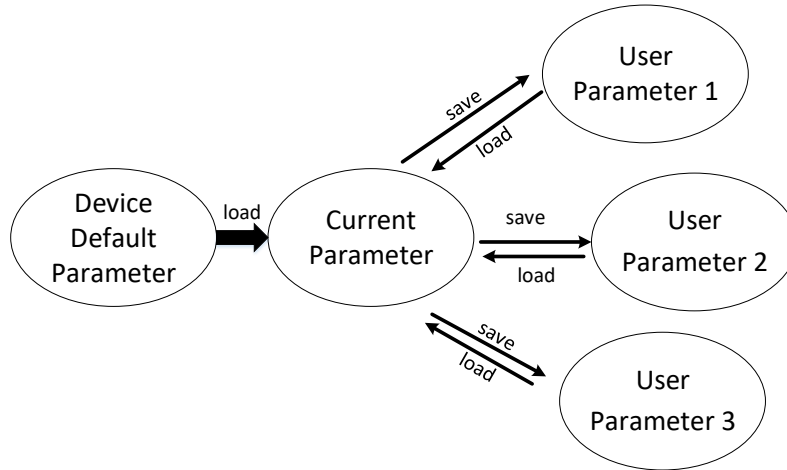

Figure 11-10 Parameter Relation

You can save parameters, load parameters and set user default as shown below.

 **NOTE**

Here we take selecting **User Set 1** as an example.

- **Save Parameters**

Click **User Set Control**, select a user set in **User Set Selector**, and click **Execute** in **User Set Save** to save parameters.

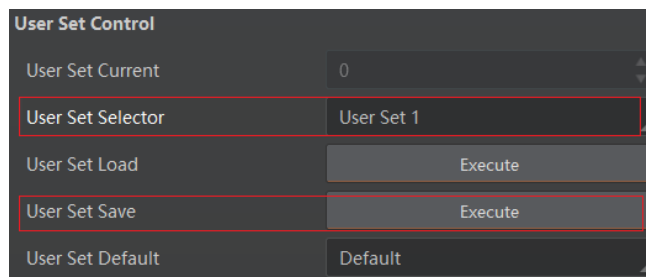

Figure 11-11 Save User Set

- **Load Parameters**

Click **User Set Control**, select a user set in **User Set Selector**, and click **Execute** in **User Set Load** to load parameters to the camera, as shown below.

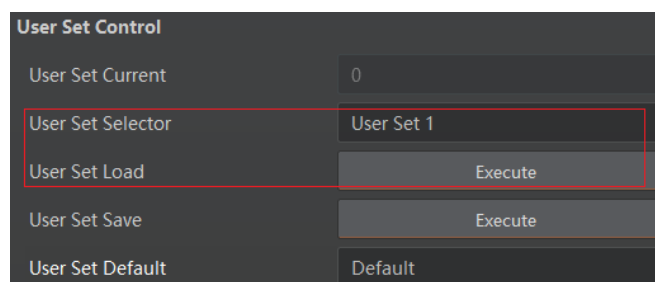

Figure 11-12 Load User Set

 **NOTE**

Loading parameters is available when connecting with camera, but without acquisition.

- **Set User Default**

You can also set default parameter by selecting parameter from drop-down list of **User Set Default**, as shown below.

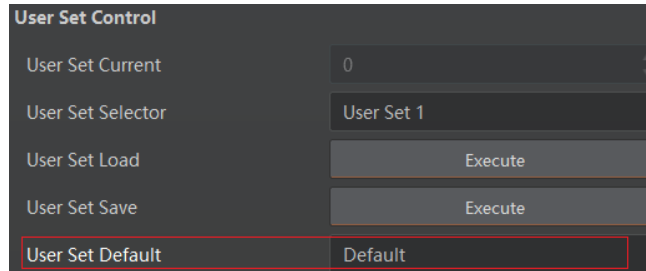

Figure 11-13 Set User Default

11.10 Set Multicast



 **NOTE**

The multicast function may differ by camera models.

The multicast function allows you to access the same camera via multiple PCs, and it has 3 modes as follows.

- **Controller and Data Receiver:** This mode allows you to read and edit the camera's parameters, and get its image data.
- **Controller:** This mode allows you to read and edit the camera's parameters, but you cannot get its image data.
- **Data Receiver:** This mode allows you read the camera's parameters and get its image data, but you cannot edit the camera's parameters.

 **NOTE**

- The same camera can be connected to only one MVS client software via the controller and data receiver or the controller mode at the same time, while in the data receiver mode, the same camera can be connected to multiple client software.
- When the multicast function is enabled, the camera icon on the client software of other PCs will become , and you can connect the camera via the data receiver mode.
- When you connect the camera via the data receiver mode, the camera icon on the client software of your PC will become , and at this time, you can read its parameters only.
- You can set multicast function for both the available camera and connected camera, but the specific settings are different.

For the available camera, you can set multicast function as follows.

Steps:

1. Right click the available camera, and click **Multicast Settings**.

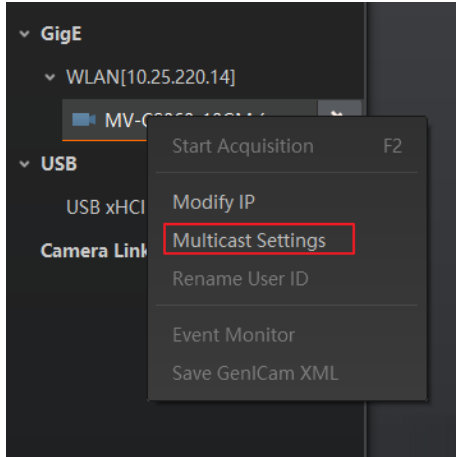

Figure 11-14 Click Multicast Settings

2. Select **Role**, and enter the **IP Address** and **Port**.
3. Click **OK**.

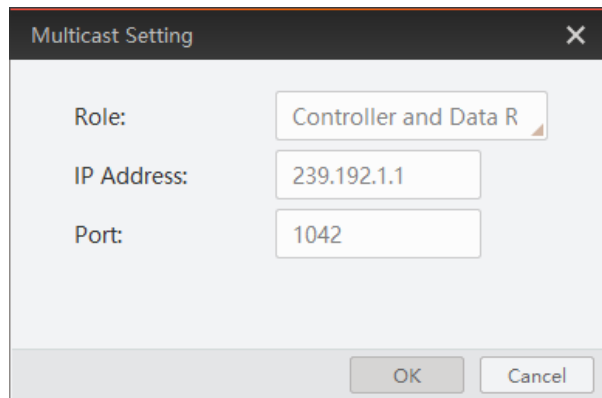

Figure 11-15 Set Multicast for Available Camera

For the connected camera, you can set multicast function as follows.

 **NOTE**

For the connected camera, only the **Controller and Data Receiver** is available.

Steps:

1. Right click the connected camera, and click **Multicast Settings**.
2. Enable the multicast function, and edit the **IP Address** and **Port**.
3. Click **OK**.

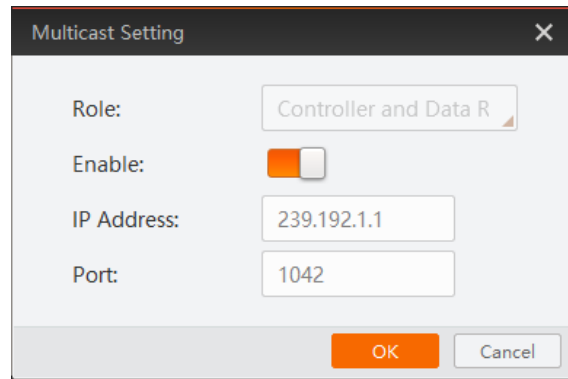

Figure 11-16 Set Multicast for Connected Camera



11.11 Update Firmware

The camera supports updating firmware via the client software.

NOTE

- Before updating, make sure power cable and others are properly connected.
- Please use the firmware package of the corresponding camera model for updating.

Steps:

1. Click **Tool > Firmware Updater** to open the update interface.
2. Click  to select the camera.
3. Click  to select the update file in the local computer.
4. Click **Update** to start updating.

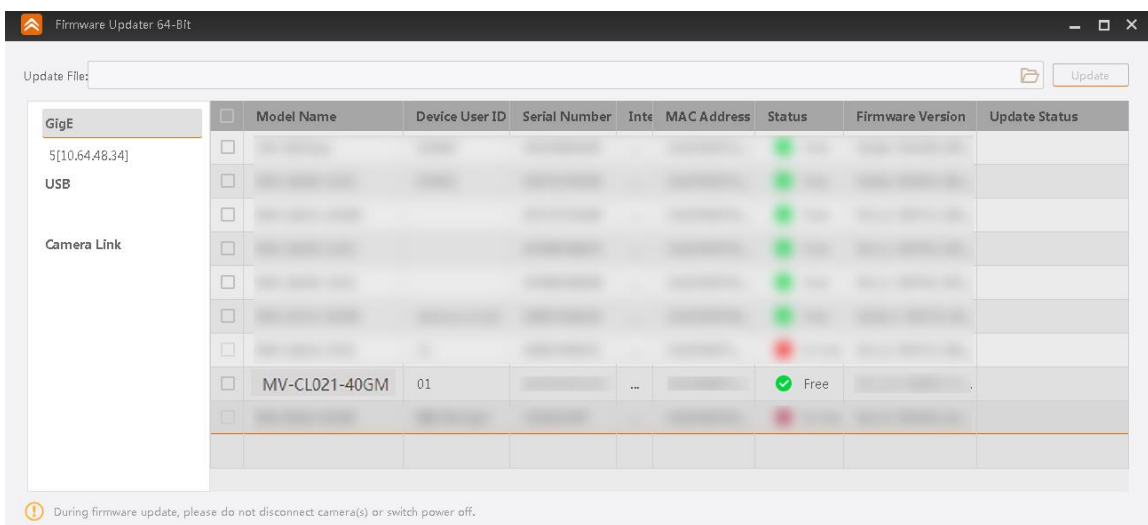

Figure 11-17 Update Firmware

 **NOTE**

- You can only update the firmware when the camera is free, and the camera will reboot automatically after updating the firmware.
- The firmware updating process may take a few minutes, please wait patiently.

Chapter 12 Troubleshooting

Table 12-1 Troubleshooting

No.	Trouble	Possible Reason	Solution
1	No camera found when running the MVS client software.	Camera is not started up normally, or network cable connection error.	Check camera power wiring (observe the indicator), and check network connection.
2	Camera connection error.	Camera and client software are not in the same network segment.	Use MVS IP Configurator tool to find the camera and edit its IP address.
3	Live view is black.	<ul style="list-style-type: none"> ● Lens aperture is set too large. ● The camera's exposure value is too small. 	<ul style="list-style-type: none"> ● Reduce lens aperture value properly. ● Increase the camera's exposure value, or enable auto exposure mode.
4	Live view is normal, but the camera cannot be triggered.	<ul style="list-style-type: none"> ● The trigger mode is not enabled, or the trigger source is incorrect. ● Incorrect trigger wiring. 	<ul style="list-style-type: none"> ● Check whether the trigger mode is enabled and selected trigger source is correct. ● Check whether trigger wiring is correct.
5	A bi-directional configurable line signal is selected as Line Selector, and Line Mode is Input currently. Why Line Mode cannot be set as Strobe	The bi-directional configurable line signal is selected as trigger source in one of line trigger/frame trigger/shaft encoder control/ frequency converter control settings.	Set other line signals as trigger source in line trigger/frame trigger/shaft encoder control/ frequency converter control settings all.

Chapter 13 Revision History

Table 13-1 Revision History

Version No.	Document No.	Date	Revision Details
V3.4.32	UD24388B	Jun. 11, 2021	<ul style="list-style-type: none"> ● Modify section Appearance. ● Modify section Interface and Indicator. ● Modify section Set Shaft Encoder Control. ● Add section View Trigger Line Rate. ● Modify section Enable Strobe Signal. ● Modify section I/O Introduction. ● Modify section Input Wiring. ● Modify section Set Pixel Format. ● Modify section Set Gamma Correction. ● Modify section Set Color Transformation Control. ● Modify section Set Hue. ● Modify section Set Saturation. ● Modify section Set LUT. ● Add section Set Flat Field Correction. ● Add section Set Space Correction. ● Modify section File Access Control.
V3.4.14	UD22897B	Feb. 1, 2021	<ul style="list-style-type: none"> ● Modify section Appearance. ● Modify section Interface and Indicator. ● Add section Set Frame Timeout. ● Modify section Set Hardware Trigger. ● Modify section Trigger Related Parameters. ● Modify section Frame/Line Tigger Cache. ● Modify section Select Output Signal.

			<ul style="list-style-type: none"> ● Modify section Enable Strobe Signal. ● Add section I/O Introduction. ● Modify section I/O Electrical Feature. ● Modify section Input Wiring. ● Modify section Set Test Pattern. ● Modify section Set Color Transformation Control. ● Add section Color Adjustment. ● Modify section Troubleshooting.
V3.4.13	UD19990B	Jun. 2, 2020	<ul style="list-style-type: none"> ● Add section Overview. ● Modify section Appearance. ● Modify section Interface and Indicator. ● Add section Set Image Compression Mode. ● Modify section Set Shading Correction. ● Modify section Device Control. ● Add section TDI Function.
V1.2.0	UD17632B	Dec. 5, 2019	<ul style="list-style-type: none"> ● Modify section Client Software Layout. ● Modify section Set Line Rate. ● Modify section Event Control. ● Add section Set Pixel Format. ● Add section Transfer Control.
V1.1.0	UD16661B	Oct. 10, 2019	<ul style="list-style-type: none"> ● Modify section Appearance. ● Add section Set Test Pattern. ● Add section Set AOI. ● Add section Color Transformation Control. ● Add section File Access Control. ● Add Appendix A Camera Parameter Index.
V1.0.0	UD14254B	April. 12, 2019	Original version.

Appendix A Camera Parameter Index

Table Appendix A-1 Camera Parameter Index

Attribute	Parameter	Section
Device Control	Device Type	Section Device Control
	Device Scan Type	
	Device Vendor Name	
	Device Model Name	
	Device Manufacturer Info	
	Device Version	
	Device Firmware Version	
	Device Serial Number	
	Device ID	
	Device User ID	
	Device Uptime (s)	
	Board Device Type	
	Device Connection Selector	
	Device Connection Speed (Mbps)	
	Device Link Selector	
	Device Link Speed (Mbps)	
	Device Link Connection Count	
	Device Link Heartbeat Mode	
	Device Stream Channel Count	
	Device Stream Channel Selector	
	Device Stream Channel Type	
	Device Stream Channel Link	
	Device Stream Channel Endianness	
Device Stream Channel Packet Size (B)		
Device Event Channel Count		

	Device Character Set	
	Device Reset	
	Device Temperature Selector	
	Device Temperature	
	Find Me	
	Device Max Throughput (Kbps)	
	Device PJ Number	
	HB Abnormal Monitor	
	HB Version	
Image Format Control	Width Max	Section Image Resolution
	Height Max	
	Region Selector	Section Set ROI
	Region Destination	
	Width	
	Height	
	Offset X	
	Offset Y	
	Reverse X	Section Set Image Reverse
	Reverse Scan Direction	Section Scan Direction
	Pixel Format	Section Set Pixel Format
	Pixel Size	
	Image Compression Mode	Section Set Image Compression Mode
	Test Pattern Generator Selector	Section Set Test Pattern
	Test Pattern	
	Binning Selector	Section Set Binning
	Binning Horizontal	
	Binning Vertical	
	Embedded Image Info Selector	Section Embedded

	Frame Spec Info	Information in Image
	TDI Mode	Section TDI Function
Acquisition Control	Acquisition Mode	Section Set Acquisition Mode
	Acquisition Stop	
	Acquisition Burst Frame Count	Section Set Line Rate
	Resulting Line Rate (Fps)	
	Acquisition Line Rate Control Enable	
	Resulting Line Rate (Hz)	
	Reference Line Rate (Hz)	
	Resulting Frame Rate (Fps)	
	Trigger Selector	
	Trigger Mode	
	Trigger Source	
	Trigger Activation	
	Trigger Partial Close	
	Trigger Delay	
	Trigger Cache Enable	
	Line Trigger Cache Enable	
	Exposure Mode	Section Set Exposure Auto
	Exposure Time (μ s)	
	Exposure Auto	
	Auto Exposure Time Lower Limit (μ s)	
	Auto Exposure Time Upper Limit (μ s)	
	Frame Timeout Enable	Section Frame Timeout
	Frame Timeout Time (ms)	
	Partial Frame Discard	
	Abandon Extra Image	
	HDR Enable	Section Set HDR

	HDR Selector	
	HDR Shutter	
Analog Control	Preamplifier Gain	Section Set Gain
	Gain (dB)	
	Gain Auto	
	Auto Gain Lower Limit (dB)	
	Auto Gain Upper Limit (dB)	
	ADC Gain x 4 Enable	
	Digital Shift	
	Digital Shift Enable	
	Brightness	Section Set Brightness
	Black Level	Section Set Black Level
	Black Level Enable	
	Balance White Auto	Section Set White Balance
	AWB Color Temperature Mode	
	Balance Ratio Selector	
	Balance Ratio	
	Gamma	Section Set Gamma Correction
	Gamma Selector	
	Gamma Enable	
	Auto Function AOI Selector	Section Set AOI
	Auto Function AOI Width	
Auto Function AOI Height		
Auto Function AOI Offset X		
Auto Function AOI Offset Y		
Auto Function AOI Usage Intensity		
Auto Function AOI Usage White Balance		
Color	CCM Enable	Section Set Color

Transformation Control	Color Transformation Selector	Transformation Control
	Color Transformation Enable	
	Color Transformation Value Selector	
	Color Transformation Value	
	Hue	Section Set Hue
	Hue Enable	
	Saturation	Section Set Saturation
	Saturation Enable	
	Color Adjustment Enable	Section Set Color Adjustment
	Color Adjustment Selector	
	Color Adjustment Hue	
	Color Adjustment Saturation	
	LUT Control	LUT Selector
LUT Enable		
LUT Index		
LUT Value		
LUT Save		
Encoder Control	Encoder Selector	Section Set Shaft Encoder Control
	Encoder Source A	
	Encoder Source B	
	Encoder Trigger Mode	
	Encoder Counter Mode	
	Encoder Counter	
	Encoder Counter Max	
	Encoder Counter Reset	
	Encoder Max Reverse Counter	
	Encoder Reverse Counter Reset	
Frequency	Input Source	Section Set Frequency

Converter Control	Signal Alignment	Converter Control
	Trigger Line Rate (Hz)	
	PreDivider	
	Multiplier	
	PostDivider	
	Resulting Trigger Line Rate (Hz)	
Shading Correction	Shading Selector	Section Set Flat Field Correction
	Activate Shading	
	NUC Enable	
	PRNUC Enable	
	PRNUC ROI Enable	
	PRNUC Width	
	PRNUC Offset X	
	FPNC User Enable	
	PRNUC User Enable	
	PRNUC User Selector	
	PRNUC Target Enable	
	PRNUC Target R	
	PRNUC Target G	
	PRNUC Target B	
	PRNUC Smooth Enable	
	Line Rate Ratio	Section Set Space Correction
	Pixel Shift	
Parallax Direction		
Digital IO Control	Line Selector	Section I/O Output
	Line Mode	
	Line Format	
	Line Status	

	Line Status All	
	Line Debouncer Time (μ s)	
	Line Inverter	
	Line Source	
	Strobe Enable	
	Strobe Source Selector	
	Strobe Line Duration	
	Strobe Line Delay	
	Strobe Line Pre Delay	
Action Control	Action Device Key	Section Set Action Command Trigger
	Action Queue Size	
	Action Selector	
	Action Group Mask	
	Action Group Key	
Counter And Timer Control	Counter Selector	Enable Strobe Signal
	Counter Event Source	
	Counter Reset Source	
	Counter Reset	
	Counter Value	
	Counter Current Value	
File Access Control	File Selector	Section File Access Control
	File Operation Selector	
	File Operation Execute	
	File Open Mode	
	File Operation Status	
	File Operation Result	
	File Size (B)	
Event Control	Event Selector	Section Event Control

	Event Notification	
Chunk Data Control	Chunk Mode Active	Section Embedded Information in Image
	Chunk Selector	
	Chunk Enable	
Transport Layer Control	Payload Size (B)	Section Transport Layer Control
	GEV Version Major	
	GEV Version Minor	
	GEV Device Mode Is Big Endian	
	GEV Device Mode Character Set	
	GEV Interface Selector	
	GEV MAC Address	
	GEV Supported Option Selector	
	GEV Supported Option	
	GEV Current IP Configuration LLA	
	GEV Current IP Configuration DHCP	
	GEV Current IP Configuration Persistent IP	
	GEV PAUSE Frame Reception	
	GEV Current IP Address	
	GEV Current Subnet Mask	
	GEV Current Default Gateway	
	GEV First URL	
	GEV Second URL	
	GEV Number Of Interfaces	
	GEV Persistent IP Address	
	GEV Persistent Subnet Mask	
	GEV Persistent Default Gateway	
	GEV Link Speed	
GEV Message Channel Count		

	GEV Stream Channel Count	
	GEV Heartbeat Timeout (ms)	
	GEV Heartbeat Disable	
	GEV Timestamp Tick Frequency (Hz)	
	Timestamp Control Latch	
	Timestamp Control Reset	
	Timestamp Control Latch Reset	
	Timestamp Value	
	GEV CCP	
	GEV MCP Host Port	
	GEV MCDA	
	GEV MCTT (ms)	
	GEV MCRC	
	GEV MCSP	
	GEV Stream Channel Selector	
	GEV SCP Interface Index	
	GEV SCP Host Port	
	GEV SCP Direction	
	GEV SCPS Fire Test Packet	
	GEV SCPS Do Not Fragment	
	GEV SCPS Big Endian	
	GEV SCPS Packet Size (B)	
	GEV SCPD	
	GEV SCDA	
	GEV SCSP	
	Gev GVSP Extended ID Mode	
Transfer Control	Transfer Selector	Section Transfer Control
	Transfer Control Selector	

	Transfer Queue Max Block Count	
	Transfer Queue Current Block Count	
	Transfer Queue Over Flow Count	
	Transfer Queue Mode	
User Set Control	User Set Current	Section Save and Load User Set
	User Set Selector	
	User Set Load	
	User Set Save	
	User Set Default	

